

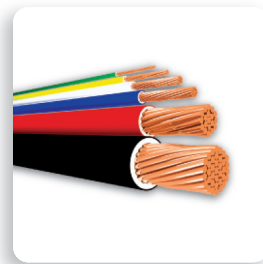

Lighting and Power Solutions for

RESIDENTIAL CONDOMINIUMS



Our Story

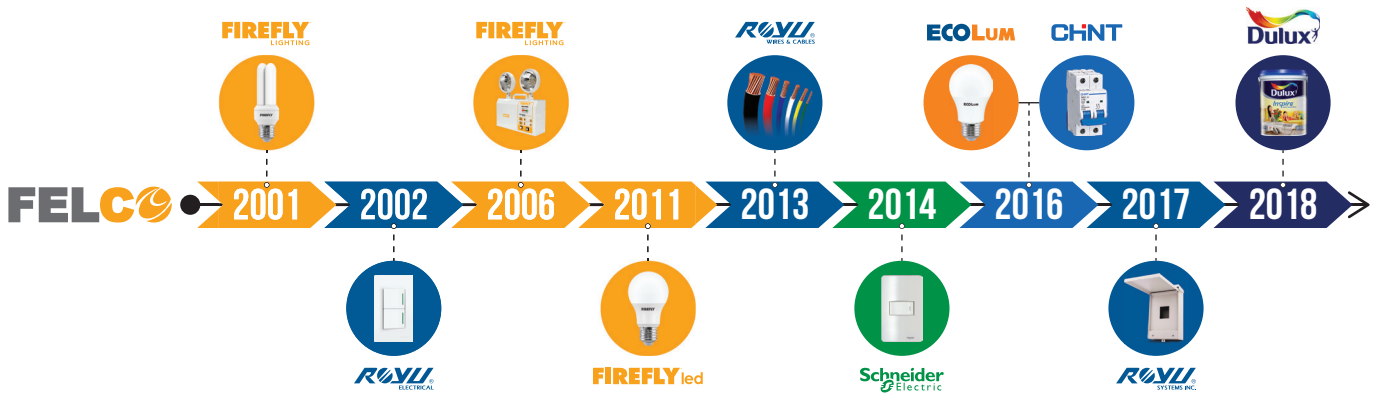

FELCO was established in 2001 to engage in the marketing and sale of various lighting and electrical products in the Philippines.

The Company was able to immediately make its presence felt in the market with the launch of its very first brand and product line, the Firefly Compact Fluorescent Lamps (CFLs). Firefly CFLs were positioned as quality products with price points accessible to the broader Filipino market, a welcome alternative to the expensive imported brands available. Since then, this passion to provide quality products at affordable prices has guided FELCO in its decision to introduce brands and products in the Philippine market.

The following year, the electrical business of FELCO was born under the brand, Roya. As with Firefly, Roya switches and outlets proved to be worthwhile alternatives to Filipino consumers given the brand's practical and functional designs, and value-for-money positioning.

2006 marked the expansion of the Firefly Lighting portfolio into the growing emergency lights category with the launch of the Firefly Emergency Lamps. With a built-in rechargeable battery and stand-by function, Firefly Emergency Lamps became a must-have for buildings and establishments given the power crisis experienced by the country back then.

In 2011, FELCO entered yet again another emerging lighting technology and category, the Light-Emitting Diode (LED), under the Firefly LED brand. The first generation Firefly LEDs had a lamp life of up to 5X longer versus the comparable CFL products, and can save as much as 80% in electrical consumption when benchmarked versus the replacement incandescent bulbs. These, coupled with Firefly's accessible price position, helped accelerate the market adoption and conversion from conventional bulbs to LEDs, and resulted to significant electrical savings for the Filipino household.

FELCO ventured into the manufacturing scene in 2013 through the manufacture and sale of building wires and communication cables under the affiliate company, Roya Industrial Corporation. Using only 100% virgin copper, a smooth nylon outer finish, dual insulation technology, and market competitive pricing, Roya Wires and Cables immediately gained market acceptance.

Consistent with the company's desire to complete its market offer to target customers and consumers across various socio-economic classes, in 2014, FELCO secured the distribution of the global brand Schneider Electric and was appointed as one of its distributors in the Philippines.

In 2016, FELCO added two more brands in its portfolio roster; Ecolum LED, a lighting brand positioned to attract the economy market and first time LED users, and secured the exclusive distributorship of Chint Electric, a market-leading brand in China. Both brands proved to be instrumental in growing the footprint of FELCO in the lighting and electrical categories.

FELCO's affiliate company, Roya Industrial Corporation, also expanded its manufacturing capabilities in 2017 to cater to the growing demand for electrical enclosures (from panelboards, distribution panels, switchboards and switchgears), that can be custom-built depending on customer requirements. This was the birth of Roya Engineering Works Division.

And to further complete its portfolio, in 2018, FELCO acquired the exclusive retail distribution of Dulux Paint, one of the leading global paint brands.

Over the years, FELCO has expanded its product lines to now consist of a wide range of lighting, electrical and other construction solutions through the brand names of Firefly, Ecolum, Roya Electrical, Chint, Schneider Electric, and Dulux Paint.

With its Customers at heart, FELCO is constantly evolving, and is on the look-out for market opportunities aligned with its mission, vision and core values.

Our Mission

Improving Filipino lives by providing quality products at affordable prices.

Our Vision

To be the partner of choice for lighting and power solutions in the Philippines.

Our Core Values



Our Nationwide Presence



Our People

FELCO credits its employees for its success. The company values each employee and is committed to helping them realize their full potential. FELCO believes that this philosophy inspires the loyalty and dedication of employees. Thus, they are highly motivated to deliver the best products and services to customers.

Our Commitment to Quality

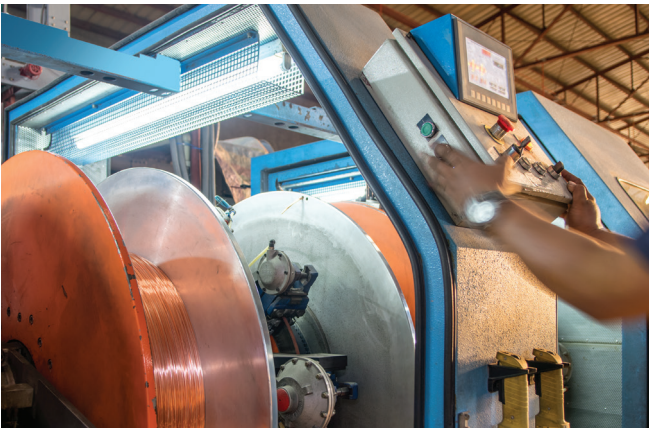
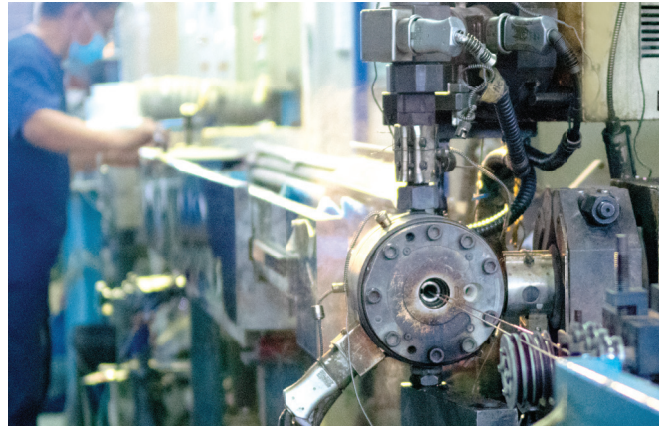
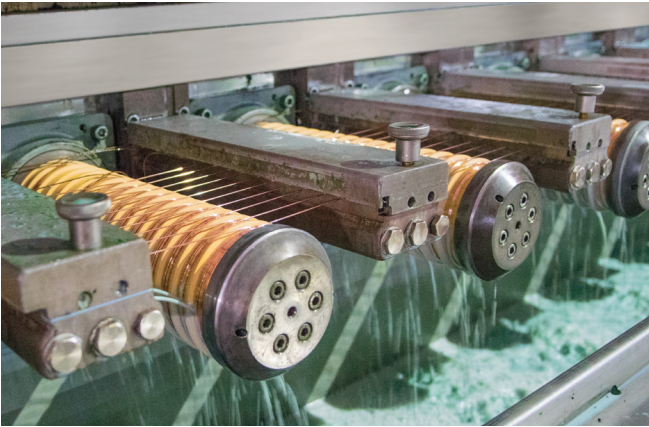

Local & International Certifications

FELCO products go through rigorous testing procedures and conform to the highest local and international standards. That is why every time you buy a FELCO product, you are assured that you get the best value for your money.



Pursuant to the provisions of Executive Order No. 101, Series of 1967, and in conjunction with the provisions of Republic Act No. 4109, Executive Order No. 913, Series of 1983 and Executive Order No. 133, Series of 1987 and their implementing rules and regulations, The Bureau of Philippine Standards hereby grants the license to use the

Philippine Standard Safety Certification Mark



CERTIFIED
Product Safety

(SYSTEM No. 5 as per ISO GUIDE 67:2004)

In favor of
ROYU INDUSTRIAL CORPORATION
 55 Centro St., Brgy. Lawang Bato, Valenzuela City

Having been assessed and found conforming to the requirements of Department Administrative Order No. 4 series of 2008 and its future amendments and revisions, PNS 35-1:2004 and its implementing guidelines, for its **THERMOPLASTIC INSULATED WIRES AND CABLES** covered in the scope of certification as described in the attached Certificate No. 1697

Issued on 19 April 2017 at Makati City, Philippines
 License No. Q-1697

This license is valid until 18 April 2020 subject to the continuing conformity with the PS certification criteria and the Terms and Conditions of this PS License.

ASISTANT SECRETARY ERNESTO V. PEREZ
 Officer-in-Charge



BUREAU OF PHILIPPINE STANDARDS
 3/F Trade and Industry Building
 391 Sam 08 Project Avenue, Makati City
 Tel. No. 832 751 4724 Fax No. 832 751 4735
 Email Address: info@bps.gov.ph
 Website: www.bps.gov.ph

This license is not valid unless signed by the BPS Bureau Director or his authorized representative and appended to a valid PS certificate.

CONTROL NO.
1-047596

Company : **ROYU INDUSTRIAL CORPORATION**

Plant Address : **55 Centro St., Brgy. Lawang Bato, Valenzuela City**

License No. : **Q-1697**

Certificate No. : **1697** Revision No. **05**

SCOPE OF CERTIFICATION

Product : **THERMOPLASTIC INSULATED WIRES AND CABLES**

Brandname : **ROYU**

Types/Model :

THHN/THWN Stranded	2.0mm ² , 3.5mm ² , 5.5mm ² , 8.0mm ² , 22mm ² , 30mm ² , 38mm ² , 50mm ² , 60mm ² , 80mm ² , & 100mm ² & 150mm ²
TW Stranded	2.0mm ² , 3.5mm ² , 5.5mm ² , & 8.0mm ²
TW Solid	1.8mm, 2.0mm, & 2.6mm

Date Approved : 23 May 2018

Nothing follows

DIRECTOR JAMES E. EMPEÑO
 BPS



BUREAU OF PHILIPPINE STANDARDS
 3/F Trade and Industry Building
 391 Sam 08 Project Avenue, Makati City
 Tel. No. 832 751 4724 Fax No. 832 751 4735
 Email Address: info@bps.gov.ph
 Website: www.bps.gov.ph



This certificate is not valid unless signed by the BPS Bureau Director or his authorized representative and appended to a valid PS Quality and/or Safety Certification Mark License.



Management System
ISO 9001:2015



www.tuv.com
 ID 9105081103

Certificate

Standard : **ISO 9001:2015**

Certificate Registr. No. : **01 100 1432602**

Certificate Holder : **FELCO**
Firefly Electric & Lighting Corporation
 6F-10F Zen Office Bldg., 1111 Natividad Lopez St., Ermita, Manila 1000 Philippines

including the locations according to annex

Scope: **Sales and Distribution of Lighting and Electrical Products**

Proof has been furnished by means of an audit that the requirements of ISO 9001:2015 are met.

Validity: **The certificate is valid from 2018-08-24 until 2020-12-03. First certification 2014**

2018-08-24



TÜVRheinland®
 Precisely Right.

www.tuv.com  

CERTIFICATE
 Product Service

No. **Z1 17 09 02190 001**

Holder of Certificate: **Firefly Electric and Lighting Corporation**
 7/F Zen Office Bldg. 1111 Natividad Lopez St. Ermita 0900 Manila PHILIPPINES



Certification Mark: 

Product: **LED Lamps (self-ballasted LED lamps)**

The product was tested on a voluntary basis and complies with the essential requirements. The certification mark shown above can be affixed on the product. It is not permitted to alter the certification mark in any way. In addition the certification holder must not transfer the certificate to third parties. See also notes overleaf.

Test report no.: **6614017007601**

Valid until: **2022-09-11**













Date, 2017-06-14
 Page 1 of 2



Richard Xu
 (Richard Xu)

Page 1 of 2

Table of Contents

Page Number	Category	
1 - 2	ELECTRICAL SOLUTIONS	
3 - 7	Building Wires	
8 - 9	Communication Cables	
10 - 21	Panel Boards & Breakers	
22 - 27	Wiring Devices	
28	LIGHTING SOLUTIONS	
29 - 42	Living Room / Dining	
43 - 48	Bedroom	
49 - 50	Kitchen	
51 - 59	Bathroom / Toilet	
60 - 64	Hallway	
65 - 66	Stairs	
67 - 77	Yard	
78 - 79	Parking	

ROYU[®] ELECTRICAL SOLUTIONS



Our Story

Royu Industrial Corporation is a manufacturing company that produces and sells building wires and communication cables under the brand Royu Wires and Cables. The company upholds the vision of providing quality and affordable products to the market that is why it uses only 100% virgin copper in the manufacturing of its wires and cables and offer it to the market at a competitive price.

Through the years, the company through Royu Systems Inc. has expanded its product portfolio and introduced electrical enclosures such as panelboards, distribution panels, switchboards and switchgears that can be custom-built to suit customer needs.

The company built its manufacturing facility in Metro Manila which uses state-of-the-art machines and equipment from Germany operated by licensed mechanical and electrical engineers. It is an affiliate of Firefly Electric and Lighting Corporation (FELCO), a leading lighting, electrical and power solutions company in the Philippines, owners of the powerhouse brands Firefly Lighting, Royu Electrical, and EcoLum LED. FELCO also distributes Chint Electric, Schneider Electric, and Dulux Paints in the Philippines.

Our Products

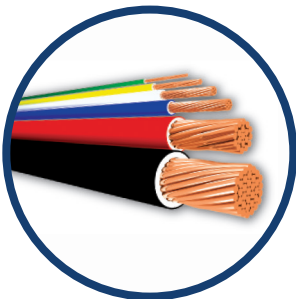

Wires & Cables



Panel Board



Breakers



Wiring Devices

Our Manufacturing Excellence

All Royu Electrical products go through a rigorous design process that optimizes the speed of production using state-of-the-art machines without compromising quality.

Royu Industrial Corp.



This European multi-wire drawing machine has a high production capacity by producing multiple wires at the same time. It is able to maintain high productivity while maximizing the electrical properties of the wire.

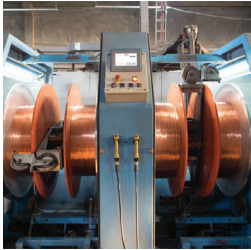

This European strander is the only one of its kind in the building cable manufacturing in the Philippines. Its new design ensures that cable quality is more consistent than its predecessors.

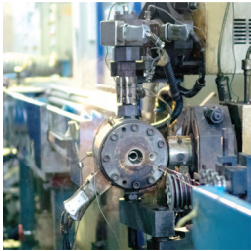

This European extrusion machine ensures that the insulation's electrical property and dimension are maximized. Problems such as off-centering, inconsistency of thickness, over or under burning of insulation materials are prevented with this machine.

Royu Systems, Inc.



Computer Controlled Pre-treatment

All metal parts are chemically treated to provide a first layer of protection and strengthen paint adhesion. The fully-automated dipping system ensures that metal parts are treated thoroughly and receive the same phosphate coating thickness.



Painting System with Robotic Spray Guns

Our German-made powder coating machine with robotic spray guns ensures an accurate powder coating thickness across all metal parts.

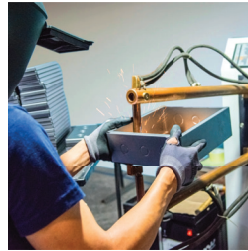

Spot Welding

An efficient welding process is in place given the high level of precision in the punching and bending processes. Components are accurately aligned and fitted resulting in products that provide high IP and IK ratings.

Our Commitment to Quality

No product is released from the manufacturing facility without undergoing quality control checks. Experienced engineers use sophisticated equipment and tests to rigorously assess the products, such as:

Royu Industrial Corp.



Profile Projector

A computer controlled measuring instrument used to measure wires and cables insulation thickness, centering, and outside diameter.



Universal Testing Machine

It is used to check the capacity of the PVC and copper to withstand loads tending to elongate. The insulation tensile strength is automatically computed by the computer attached to the measuring equipment.



Thermostatic Water Tank

It tests the insulation resistance and withstand voltage of wires and cables submerged in water. It can be used in conjunction with the insulation resistance testing machine and withstand voltage testing machine.

Royu Systems, Inc.



Primary Current Injection Test System

The most advanced Primary Current Injection Test System is used to inject currents in the circuit to assess whether the relay will trip and determine the length of time before the trip is triggered.



Thermal Imager

This imager combined with current injector can simulate the temperature rise of breakers, busbars, and their connections.

BUILDING WIRES



ROYLI[®]
INDUSTRIAL CORPORATION



CERTIFIED
Product Safety
License No. Q-1697

THHN/THWN Stranded

HIGH QUALITY. SAFE. **VALUE FOR MONEY.**

Passed through rigorous quality and performance tests for product safety and reliability.

100%

- ✓ **CONDUCTIVITY**
in **VIRGIN COPPER**
- ✓ **LEAD-FREE PVC** with
DUAL INSULATION
- ✓ **QUALITY PRODUCT**



600
Volts

Withstands
90°C
in dry locations

Withstands
75°C
in wet locations

STRANDED WIRE

ROYU's High-Purity Copper Conductor		VS	Low-Purity Copper Conductor	
<p>✓ SPACE USED</p> <p>20% Insulation</p> <p>60% Conductor</p> <p>20% Insulation</p> <p>Pure copper is soft and can be compressed.</p>			<p>✗ SPACE USED</p> <p>40% Insulation</p> <p>80% Conductor</p> <p>40% Insulation</p> <p>Low-purity copper is hard and sticks out, resulting in uneven insulation thickness.</p>	
<p>✓</p> <p>Pure copper is flexible and strong.</p>			<p>✗</p> <p>Low-purity copper conductor can break easily during installation.</p>	

ROYU's High-Grade Insulation		VS	Low Grade Insulation	
<p>✓</p> <p>Smooth wires minimize friction during installation.</p>			<p>✗</p> <p>Rough wires could peel during installation.</p>	
<p>✓ SPACE USED</p> <p>20% Insulation</p> <p>60% Conductor</p> <p>20% Insulation</p> <p>ROYU's advanced manufacturing process ensures consistent insulation thickness.</p>			<p>✗ SPACE USED</p> <p>30% Insulation</p> <p>60% Conductor</p> <p>10% Insulation</p> <p>Inconsistent insulation thickness may damage easily and can cause fire.</p>	
<p>✓</p> <p>Flame retardant. It extinguishes fire in less than 30 seconds.</p>			<p>✗</p> <p>Burning continues even when source fire is extinguished.</p>	

SOLID WIRE

ROYU's High-Purity Copper Conductor		VS	Low-Purity Copper Conductor	
<p>✓</p> <p>Pure copper is flexible and strong.</p>			<p>✗</p> <p>Low-purity copper conductor can break easily during installation.</p>	

ROYU's High-Grade Insulation		VS	Low Grade Insulation	
<p>✓</p> <p>Smooth wires minimize friction during installation.</p>			<p>✗</p> <p>Rough wires could peel during installation.</p>	
<p>✓ SPACE USED</p> <p>20% Insulation</p> <p>60% Conductor</p> <p>20% Insulation</p> <p>ROYU's advanced manufacturing process ensures consistent insulation thickness.</p>			<p>✗ SPACE USED</p> <p>30% Insulation</p> <p>60% Conductor</p> <p>10% Insulation</p> <p>Inconsistent insulation thickness may damage easily and can cause fire.</p>	
<p>✓</p> <p>Flame retardant. It extinguishes fire in less than 30 seconds.</p>			<p>✗</p> <p>Burning continues even when source fire is extinguished.</p>	

Building Wires

Benefits:

- 100% Effective Conductivity due to its **VIRGIN COPPER WIRES**.
- Safe and Reliable Installation due to its high quality and **SMOOTH NYLON** that protects the wire to damage easily.
- Superior Insulation due to the higher electrical resistivity provided by the **DUAL INSULATION TECHNOLOGY**.

Resistant to:

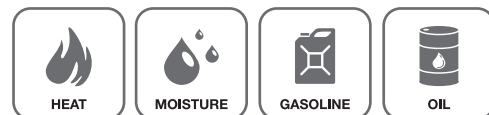

Application:

Mainly used in conduit and cable trays for services, feeders & branch circuits in residential, commercial or industrial installations.

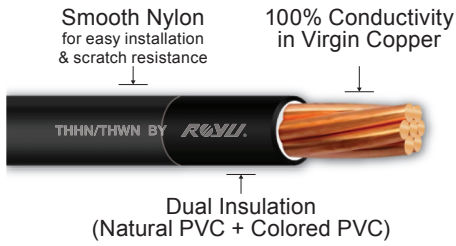

Item Code	Gauge	Size mm ²	90°C THHN Ampacity*	Meters / Pack.				Available Colors Red, Yellow, Green, Blue, White & Black
				BOX	SPOOL	COIL	REEL	
RTN14A	14 AWG	2.0 mm ²	35	150M / Box				● ● ● ● ● ●
				750M / Spool				● ● ●
RTN12A	12 AWG	3.5 mm ²	40	150M / Box				● ● ● ● ● ●
				500M / Spool				● ● ●
RTN10A	10 AWG	5.5 mm ²	55	150M / Box				● ● ● ● ● ●
				350M / Spool				●
RTN8A	8 AWG	8.0 mm ²	75	100M / Box				● ● ● ● ● ●
				200M / Spool				●
RTN6A	6 AWG	14 mm ²	110	150M / Coil				● ● ● ● ● ●
RTN4A	4 AWG	22 mm ²	145	150M / Coil				● ● ● ● ● ●
RTN2A	2 AWG	30 mm ²	165	150M / Coil				● ● ● ● ● ●
RTN1A	1 AWG	38 mm ²	195	300M / Reel				● ● ● ● ● ●
RTN1/0A	1/0 AWG	50 mm ²	235	300M / Reel				● ● ● ● ● ●
RTN2/0A	2/0 AWG	60 mm ²	265	300M / Reel				● ● ● ● ● ●
RTN3/0A	3/0 AWG	80 mm ²	325	300M / Reel				● ● ● ● ● ●
RTN4/0A	4/0 AWG	100 mm ²	380	300M / Reel				● ● ● ● ● ●
RTN250M	250 MCM	125 mm ²	445	300M / Reel				● ● ● ● ● ●
RTN300M	300 MCM	150 mm ²	505	300M / Reel				● ● ● ● ● ●
RTN400M	400 MCM	200 mm ²	590	300M / Reel				● ● ● ● ● ●
RTN500M	500 MCM	250 mm ²	685	300M / Reel				● ● ● ● ● ●

*Allowable Ampacity of Single-Insulated Conductors rated up to and including 2000 Volts in Free Air based on Ambient Temperature of 30° C as per the latest edition of the Philippine Electrical Code (PEC 2017).

ROYU ROYUX NM Non Metallic Sheathed Cable

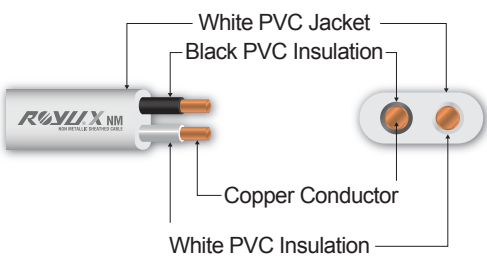

Item Code	Gauge	Size	Meters / Pack.		Available Colors
			BOX	COIL	
RNM14AXWT	14	1.6mm/2C	75M / Box		○ White
			300M / Coil		○ White
RNM12AXWT	12	2.0mm/2C	75M / Box		○ White
			300M / Coil		○ White
RNM10AXWT	10	2.6mm/2C	75M / Box		○ White

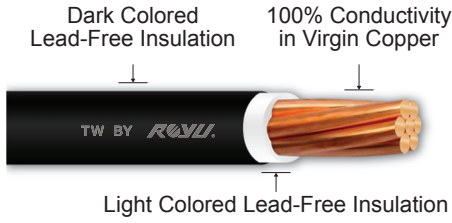

Item Code	Gauge	Size	90°C THHN Ampacity*	Meters / Pack.	Available Colors
		mm ²		BOX	
RTW14ABK150	14 AWG	2.0 mm ²	20	150M / Box	● Black
RTW12ABK150	12 AWG	3.5 mm ²	25	150M / Box	● Black
RTW10ABK150	10 AWG	5.5 mm ²	30	150M / Box	● Black
RTW8ABK100	8 AWG	8.0 mm ²	40	100M / Box	● Black

*Allowable Ampacity of Single-Insulated Conductors rated up to and including 2000 Volts in Free Air based on Ambient Temperature of 30° C as per the latest edition of the Philippine Electrical Code (PEC 2017).

ROYU TW Solid Thermoplastic Water-resistant

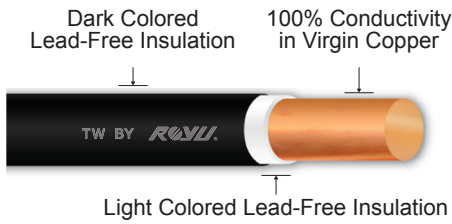

Item Code	Gauge	Size	90°C THHN Ampacity*	Meters / Pack.	Available Colors
		mm ²		BOX	
RTW14AXBK150	14 AWG	1.6 mm ²	25	150M / Box	● Black
RTW12AXBK150	12 AWG	2.0 mm ²	30	150M / Box	● Black
RTW10AXBK150	10 AWG	2.6 mm ²	40	150M / Box	● Black

*Allowable Ampacity of Single-Insulated Conductors rated up to and including 2000 Volts in Free Air based on Ambient Temperature of 30° C as per the latest edition of the Philippine Electrical Code (PEC 2017).

ROYU Bare Copper Solid

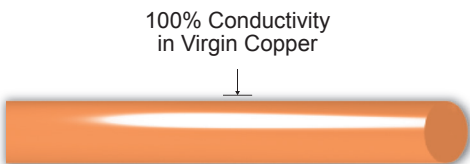

Item Code	Gauge	Size	Meters / Pack.
		mm ²	
RBC14AX1	14 AWG	1.6 mm ²	per meter
RBC12AX1	12 AWG	2.0 mm ²	per meter
RBC10AX1	10 AWG	2.6 mm ²	per meter

Building Wires

100% Conductivity
in Virgin Copper

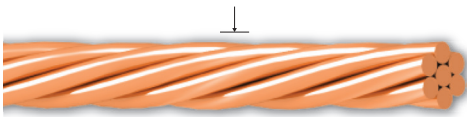

Item Code	Gauge	Size	Meters / Pack.
		mm ²	
RBC8A1	8 AWG	8.0 mm ²	per meter
RBC6A1	6 AWG	14.0 mm ²	per meter
RBC4A1	4 AWG	22.0 mm ²	per meter
RBC2A1	2 AWG	30.0 mm ²	per meter
RBC1A1	1 AWG	38.0 mm ²	per meter
RBC1/0A1	1/0 AWG	50.0 mm ²	per meter
RBC2/0A1	2/0 AWG	60.0 mm ²	per meter
RBC3/0A1	3/0 AWG	80.0 mm ²	per meter
RBC4/0A1	4/0 AWG	100.0 mm ²	per meter
RBC250M1	250 MCM	125.0 mm ²	per meter
RBC300M1	300 MCM	150.0 mm ²	per meter
RBC400M1	400 MCM	200.0 mm ²	per meter
RBC500M1	500 MCM	250.0 mm ²	per meter

ROYLI® Flat Cord Stranded, Parallel, Thermoplastic



Item Code	Gauge	Size	Type	Meters / Pack.	Available Colors
		mm ²		SPOOL	
RFC22A	22 AWG	0.3 mm ²	SPT1	150M / Spool	<ul style="list-style-type: none"> ● Black ○ White ● Black & ● Red (Speaker Wire)
RFC20A	20 AWG	0.5 mm ²	SPT1	150M / Spool	
RFC18A	18 AWG	0.75 mm ²	SPT1	150M / Spool	
RFC16A	16 AWG	1.25 mm ²	SPT2	150M / Spool	

COMMUNICATION CABLES



Coaxial Cable

HIGH QUALITY. SAFE. **VALUE FOR MONEY.**

Engineered to link electronic equipment in providing reliable communication connections.

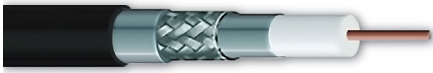

Item Code	Description	Meters / Pack.
		
RRG6CCSTS305	RG6, Copper Clad Steel Conductor, Triple Shield	305M / Plywood Reel
RRG59CCSDS305	RG59, Copper Clad Steel Conductor, High Performance Braided Dual Shield	305M / Plywood Reel

ROYLI LAN Cable

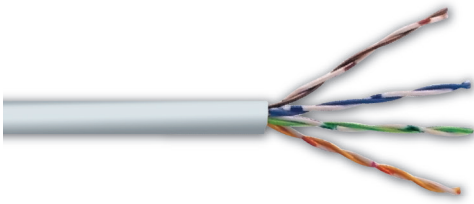

Item Code	Description	Meters / Pack.
RCAT5EUTPGY305	Category 5e, Unshielded Twisted Pair, Grey jacket	305M / Pulley Box

ROYLI CAT3 UTP Network Cable



Item Code	Description	Meters / Pack.
RCAT3UTPGY305	2 Twisted Pairs, Category 3, Unshielded Twisted Pair, Grey Jacket	305M / Pulley Box

ROYLI Telephone Cable



Item Code	Description	Meters / Pack.
		
R1PCAT3UTPGY1000	1 Twisted Pair, Category 3, Unshielded Twisted Pair, Grey Jacket	1000M / Plywood Reel

PANEL BOARDS & BREAKERS



Low Voltage
Switchgear



HIGH QUALITY. SAFE. **VALUE FOR MONEY.**

Offers ready-made and custom-built electrical enclosures and accessories.



Automatic Transfer Switch



Main Distribution Panel



Lighting Panel

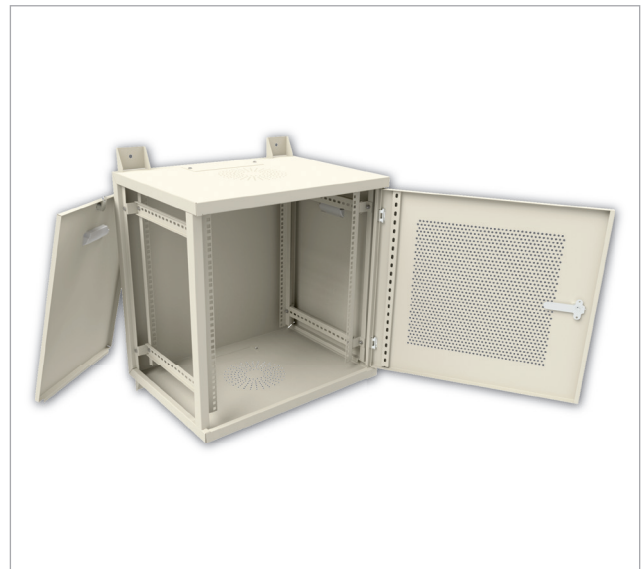

Network Cabinet



Circuit Breaker Gutter



Cable Trays & Ladder

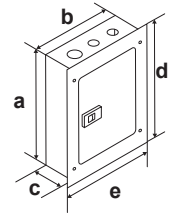

Item Code	Poles per Breaker	Can fit up to	Dimensions (mm)				
			a	b	c	d	e
RPF01P2N04	2P Miniature Circuit Plug-In Breaker	4 Breakers / 1 Main + 3 Branches	212	230	85	226	260
RPF01P2N06	2P Miniature Circuit Plug-In Breaker	6 Breakers / 1 Main + 5 Branches	263	230	85	277	260
RPF01P2N08	2P Miniature Circuit Plug-In Breaker	8 Breakers / 1 Main + 7 Branches	313	230	85	338	263
RPF01P2N10	2P Miniature Circuit Plug-In Breaker	10 Breakers / 1 Main + 9 Branches	363	230	85	388	263
RPF01P2N12	2P Miniature Circuit Plug-In Breaker	12 Breakers / 1 Main + 11 Branches	413	230	85	438	263

• Body and cover are made of powder-coated thick metal sheets to prevent corrosion and maintain good condition for long-lasting use.

ROYLI® Metal Base Panel Box Flush-Mounted Type

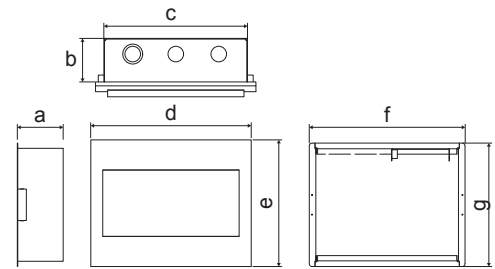

Item Code	Poles per Breaker	Can fit up to	Dimensions (mm)						
			a	b	c	d	e	f	g
RUMF01D2N08	2P Miniature Circuit Breaker	4 Breakers	80	74	177	208	222	198.4	208.4
RUMF01D2N12	2P Miniature Circuit Breaker	6 Breakers	80	76	250.5	280	221	271.9	215.4
RUMF01D2N18	2P Miniature Circuit Breaker	9 Breakers	85	81	356	397	256	377.4	238.4
RUMF01D2N24	2P Miniature Circuit Breaker	12 Breakers	90	86	247.5	300	345	268.9	325.4

ROYLI® Circuit Breaker Enclosure Surface Type

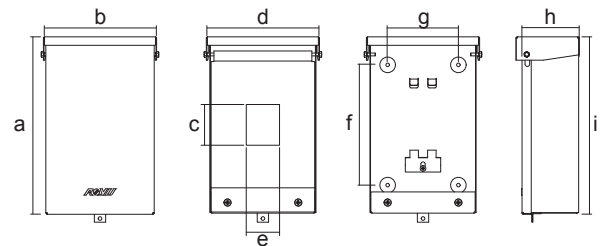

Item Code	Type	Dimensions (mm)								
		a	b	c	d	e	f	g	h	i
RES03B2N00	NEMA Type 3R - Bolt-On	250.80	153.20	57.55	150.00	47.00	170.00	100.00	80.00	249.20

Panel Boards

Plug-in Type



2-Pole Circuit Breaker
Screw Type Terminal

Item Code	Voltage	Rated Current
	V	A
RCB15	220V~	15A
RCB20	220V~	20A
RCB30	220V~	30A
RCB40	220V~	40A
RCB60	220V~	60A



2-Pole Circuit Breaker
Mechanical Lug Terminal

Item Code	Voltage	Rated Current
	V	A
RCB15-60	230V~	15A
RCB20-60	230V~	20A
RCB30-60	230V~	30A
RCB40-60	230V~	40A
RCB60-60	230V~	60A
RCB100-60	230V~	100A

Bolt-On Type



2-Pole Circuit Breaker
Screw Type Terminal

Item Code	Voltage	Rated Current
	V	A
RCBB15	220V~	15A
RCBB20	220V~	20A
RCBB30	220V~	30A
RCBB40	220V~	40A
RCBB60	220V~	60A



2-Pole Circuit Breaker
Mechanical Lug Terminal

Item Code	Voltage	Rated Current
	V	A
RCBB15-60	230V~	15A
RCBB20-60	230V~	20A
RCBB30-60	230V~	30A
RCBB40-60	230V~	40A
RCBB60-60	230V~	60A
RCBB100-60	230V~	100A

ROYLI PBX Boxes

Benefits:

- Flame Retardant
- Excellent Chemical Resistant
- Made of High Quality PP Material making the product hard but flexible



Junction Box
RJB1



Junction Box Cover w/ Screw
RJB2

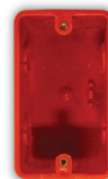

Utility Box
RUB1



Surface Utility Box
RUB2

4.5KA



Item Code	Poles	KA	Voltage	Modules	Rated Current
		KA	VAC		A
EB 1P C1 4.5KA	1P	4.5	400	1 Module	1
EB 1P C6 4.5KA	1P	4.5	400	1 Module	6
EB 1P C10 4.5KA	1P	4.5	400	1 Module	10
EB 1P C16 4.5KA	1P	4.5	400	1 Module	16
EB 1P C20 4.5KA	1P	4.5	400	1 Module	20
EB 1P C32 4.5KA	1P	4.5	400	1 Module	32
EB 1P C40 4.5KA	1P	4.5	400	1 Module	40
EB 1P C50 4.5KA	1P	4.5	400	1 Module	50
EB 1P C63 4.5KA	1P	4.5	400	1 Module	63

EB 2P C2 4.5KA	2P	4.5	400	2 Modules	2
EB 2P C4 4.5KA	2P	4.5	400	2 Modules	4
EB 2P C6 4.5KA	2P	4.5	400	2 Modules	6
EB 2P C10 4.5KA	2P	4.5	400	2 Modules	10
EB 2P C16 4.5KA	2P	4.5	400	2 Modules	16
EB 2P C20 4.5KA	2P	4.5	400	2 Modules	20
EB 2P C25 4.5KA	2P	4.5	400	2 Modules	25
EB 2P C32 4.5KA	2P	4.5	400	2 Modules	32
EB 2P C40 4.5KA	2P	4.5	400	2 Modules	40
EB 2P C50 4.5KA	2P	4.5	400	2 Modules	50
EB 2P C63 4.5KA	2P	4.5	400	2 Modules	63

EB 3P C6 4.5KA	3P	4.5	400	3 Modules	6
EB 3P C10 4.5KA	3P	4.5	400	3 Modules	10
EB 3P C16 4.5KA	3P	4.5	400	3 Modules	16
EB 3P C20 4.5KA	3P	4.5	400	3 Modules	20
EB 3P C32 4.5KA	3P	4.5	400	3 Modules	32
EB 3P C40 4.5KA	3P	4.5	400	3 Modules	40
EB 3P C50 4.5KA	3P	4.5	400	3 Modules	50
EB 3P C63 4.5KA	3P	4.5	400	3 Modules	63

6KA



Item Code	Poles	KA	Voltage	Modules	Rated Current
		KA	VAC		A
EBG 1P C10 6KA	1P	6	400	1 Module	10
EBG 1P C16 6KA	1P	6	400	1 Module	16
EBG 1P C20 6KA	1P	6	400	1 Module	20
EBG 1P C32 6KA	1P	6	400	1 Module	32
EBG 1P C40 6KA	1P	6	400	1 Module	40

EBG 2P C2 6KA	2P	6	400	2 Modules	2
EBG 2P C10 6KA	2P	6	400	2 Modules	10
EBG 2P C16 6KA	2P	6	400	2 Modules	16
EBG 2P C20 6KA	2P	6	400	2 Modules	20
EBG 2P C25 6KA	2P	6	400	2 Modules	25
EBG 2P C32 6KA	2P	6	400	2 Modules	32
EBG 2P C40 6KA	2P	6	400	2 Modules	40

EBG 3P C6 6KA	3P	6	400	3 Modules	6
EBG 3P C10 6KA	3P	6	400	3 Modules	10
EBG 3P C16 6KA	3P	6	400	3 Modules	16
EBG 3P C20 6KA	3P	6	400	3 Modules	20
EBG 3P C25 6KA	3P	6	400	3 Modules	25
EBG 3P C32 6KA	3P	6	400	3 Modules	32
EBG 3P C40 6KA	3P	6	400	3 Modules	40

Breakers

6KA with ON/OFF indicator



Item Code	Poles	KA	Voltage	Modules	Rated Current
		KA	VAC		A
NB1-631PC166KADB	1P	6	400	1 Module	16
NB1-631PC206KADB	1P	6	400	1 Module	20
NB1-631PC326KADB	1P	6	400	1 Module	32
NB1-631PC406KADB	1P	6	400	1 Module	40
NB1-631PC506KADB	1P	6	400	1 Module	50
NB1-631PC636KADB	1P	6	400	1 Module	63

NB1-632PC166KADB	2P	6	400	2 Modules	16
NB1-632PC206KADB	2P	6	400	2 Modules	20
NB1-632PC326KADB	2P	6	400	2 Modules	32
NB1-632PC406KADB	2P	6	400	2 Modules	40
NB1-632PC506KADB	2P	6	400	2 Modules	50
NB1-632PC636KADB	2P	6	400	2 Modules	63

NB1-633PC166KADB	3P	6	400	3 Modules	16
NB1-633PC206KADB	3P	6	400	3 Modules	20
NB1-633PC326KADB	3P	6	400	3 Modules	32
NB1-633PC406KADB	3P	6	400	3 Modules	40
NB1-633PC506KADB	3P	6	400	3 Modules	50
NB1-633PC636KADB	3P	6	400	3 Modules	63

10KA with ON/OFF indicator



Item Code	Poles	KA	Voltage	Modules	Rated Current
		KA	VAC		A
NB1-63H1PC1010KA	1P	10	400	1 Module	10
NB1-63H1PC1610KA	1P	10	400	1 Module	16
NB1-63H1PC2010KA	1P	10	400	1 Module	20
NB1-63H1PC3210KA	1P	10	400	1 Module	32
NB1-63H1PC4010KA	1P	10	400	1 Module	40
NB1-63H1PC5010KA	1P	10	400	1 Module	50
NB1-63H1PC6310KA	1P	10	400	1 Module	63

NB1-63H2PC1010KA	2P	10	400	2 Modules	10
NB1-63H2PC1610KA	2P	10	400	2 Modules	16
NB1-63H2PC2010KA	2P	10	400	2 Modules	20
NB1-63H2PC2510KA	2P	10	400	2 Modules	25
NB1-63H2PC3210KA	2P	10	400	2 Modules	32
NB1-63H2PC4010KA	2P	10	400	2 Modules	40
NB1-63H2PC5010KA	2P	10	400	2 Modules	50
NB1-63H2PC6310KA	2P	10	400	2 Modules	63

NB1-63H3PC610KA	3P	10	400	3 Modules	6
NB1-63H3PC1010KA	3P	10	400	3 Modules	10
NB1-63H3PC1610KA	3P	10	400	3 Modules	16
NB1-63H3PC2010KA	3P	10	400	3 Modules	20
NB1-63H3PC3210KA	3P	10	400	3 Modules	32
NB1-63H3PC4010KA	3P	10	400	3 Modules	40
NB1-63H3PC5010KA	3P	10	400	3 Modules	50
NB1-63H3PC6310KA	3P	10	400	3 Modules	63

6KA



Item Code	Poles	KA	Voltage	Modules	Rated Current
		KA	VAC		A
DZ158-1251P80A6KA	1P	6	400	1.5 Modules	80
DZ158-1251P100A6KA	1P	6	400	1.5 Modules	100
DZ158-1251P125A6KA	1P	6	400	1.5 Modules	125



Item Code	Poles	KA	Voltage	Modules	Rated Current
		KA	VAC		A
DZ158-1252P100A6KA	2P	6	400	3 Modules	100

10KA



Item Code	Poles	KA	Voltage	Modules	Rated Current
		KA	VAC		A
DZ158-1251P80A10K	1P	10	400	1.5 Modules	80
DZ158-1251P100A10K	1P	10	400	1.5 Modules	100
DZ158-1251P125A10K	1P	10	400	1.5 Modules	125



Item Code	Poles	KA	Voltage	Modules	Rated Current
		KA	VAC		A
DZ158-125 2P 80A	2P	10	400	3 Modules	80
DZ158-125 2P 100A	2P	10	400	3 Modules	100
DZ158-125 2P 125A	2P	10	400	3 Modules	125



Item Code	Poles	KA	Voltage	Modules	Rated Current
		KA	VAC		A
DZ158-125 3P 80A	3P	10	400	4.5 Modules	80
DZ158-125 3P 100A	3P	10	400	4.5 Modules	100
DZ158-125 3P 125A	3P	10	400	4.5 Modules	125

Breakers



**6KA, 30mA, 230VAC, 2 Modules
(without over current protection)**

Item Code	Poles	AT	AF	KA
		AT	AF	KA
NL1-63 2P 25A 30MA	2P	25	63	6
NL1-63 2P 40A 30MA	2P	40	63	6
NL1-63 2P 63A 30MA	2P	63	63	6

**10KA, 30mA, 230VAC, 2 Modules
(without over current protection)**

Item Code	Poles	AT	AF	KA
		AT	AF	KA
NL1-632P40A30MA10KA	2P	40	63	10
NL1-632P63A30MA10KA	2P	63	63	10

CHNT Surge Protector



Surge Protector NU6-II

Item Code	Poles	Voltage	Modules	KA
		VAC		KA
NU6-II 40kA/385V 2	2P	385	2 Modules	40
NU6-II 40kA/460V 2	2P	460	2 Modules	40
NU6-II 40kA/385V 3	3P	385	3 Modules	40
NU6-II 40kA/460V 3	3P	460	3 Modules	40

CHNT Enclosures



Distribution Box with Busbar

Item Code	Modules	Type
DB-2F	2-Module	Flush Type
DB-4F	4-Module	Flush Type
DB-6F	6-Module	Flush Type
DB-8F	8-Module	Flush Type
DB-12F	12-Module	Flush Type
DB-18F	18-Module	Flush Type
DB-24F	24-Module	Flush Type
DB-36F	36-Module	Flush Type



Distribution Box with Busbar

Item Code	Modules	Type
DB-4S	4-Module	Surface Type
DB-6S	6-Module	Surface Type
DB-8S	8-Module	Surface Type
DB-12S	12-Module	Surface Type
DB-18S	18-Module	Surface Type
DB-24S	24-Module	Surface Type
DB-36S	36-Module	Surface Type

Metal Enclosure

Wall Mount, Indoor & Outdoor Applications, IP54,
Galvanized Steel, Powder Coated
NXW5-2520-6050 1.2mm Thickness, NXW5-7050-10080 1.5mm Thickness



Item Code	Dimensions
NXW5-2520/15	250x200x150
NXW5-3025/15	300x250x150
NXW5-3030/20	300x300x200
NXW5-4030/15	400x300x150
NXW5-4040/20	400x400x200
NXW5-5040/15	500x400x150
NXW5-5040/20	500x400x200
NXW5-6050/20	600x500x200
NXW5-7050/20	700x500x200
NXW5-7050/25	700x500x250
NXW5-8060/20	800x600x200
NXW5-8060/30	800x600x300
NXW5-10080/30	1000x800x300

CHNT Air Circuit Breaker



Fixed Type, Manually Operated
Rated Voltage 690VAC, KA Rating @ 400VAC

Item Code	Poles	AT	AF	KA
		AT	AF	KA
NA1-2000-1600M/3	3P	1600	2000	80
NA1-2000-2000M/3	3P	2000	2000	80
NA1-3200-3200M/3	3P	3200	3200	80

CHNT Motor Protection Circuit Breaker



Item Code	Poles	KA	Voltage	Rated Current
		KA	VAC	A
NS2-25 4-6.3A	3P	100	690	4-6.3
NS2-25 6-10A	3P	100	690	6-10
NS2-25 9-14A	3P	100	690	9-14
NS2-25 13-18A	3P	100	690	13-18
NS2-25 17-23A	3P	100	690	17-23
NS2-25 20-25A	3P	100	690	20-25

CHNT Moulded Case Circuit Breaker - MCCB



Rated Voltage 690VAC, KAIC rating based on 400VAC

Item Code	Poles	AT	AF	KA
		AT	AF	KA
NM1-125H-2P-25A	2P	25	125	50
NM1-125H/2300 32A	2P	32	125	50
NM1-125H/2300 40A	2P	40	125	50
NM1-125H/2300 50A	2P	50	125	50
NM1-125H/2300 63A	2P	63	125	50
NM1-125H/2300 80A	2P	80	125	50
NM1-125H/2300 100A	2P	100	125	50
NM1-125H/2300 125A	2P	125	125	50
NM1-250H/2300 125A	2P	125	250	50
NM1-250H/2300 160A	2P	160	250	50
NM1-250H/2300 180A	2P	180	250	50
NM1-250H/2300 200A	2P	200	250	50
NM1-250H/2300 225A	2P	225	250	50

Breakers



Item Code	Poles	AT	AF	KA
		AT	AF	KA
NM1-125C/3300 32A	3P	32	125	20
NM1-125C/3300 40A	3P	40	125	20
NM1-125C/3300 50A	3P	50	125	20
NM1-125C/3300 63A	3P	63	125	20
NM1-125C/3300 80A	3P	80	125	20
NM1-125C/3300 100A	3P	100	125	20
NM1-125C/3300 125A	3P	125	125	20

Rated Voltage 690VAC, KA rating on 400VAC



Item Code	Poles	AT	AF	KA
		AT	AF	KA
NM1-63S/3300 16A	3P	16	63	15
NM1-63S/3300 20A	3P	20	63	15
NM1-125S/3300 32A	3P	32	125	25
NM1-125S/3300 40A	3P	40	125	25
NM1-125S/3300 50A	3P	50	125	25
NM1-125S/3300 63A	3P	63	125	25
NM1-125S/3300 80A	3P	80	125	25
NM1-125S/3300 100A	3P	100	125	25
NM1-125S/3300 125A	3P	125	125	25
NM1-250S-3P-100A	3P	100	250	25
NM1-250S/3300 125A	3P	125	250	25
NM1-250S/3300 160A	3P	160	250	25
NM1-250S/3300 180A	3P	180	250	25
NM1-250S/3300 200A	3P	200	250	25
NM1-250S/3300 225A	3P	225	250	25
NM1-250S/3300 250A	3P	250	250	25
NM1-400S/3300 315A	3P	315	400	35
NM1-400S/3300 350A	3P	350	400	35
NM1-400S/3300 400A	3P	400	400	35
NM1-630S/3300 500A	3P	500	400	35
NM1-630S/3300 630A	3P	630	400	35

Item Code	Poles	AT	AF	KA
		AT	AF	KA
NM1-63H/3300 16A	3P	16	63	35
NM1-63H/3300 20A	3P	20	63	35
NM1-125H-3P-80A	3P	80	125	50
NM1-250H-3P-250A	3P	250	250	50
NM1-630H-3P-630A	3P	630	630	50
NM1-800H/3300 700A	3P	700	800	60
NM1-800H/3300 800A	3P	800	800	60
NM1-1250H 1000A	3P	1000	125	65
NM1-1250H 1250A	3P	1250	125	65

iC60N (C-curve)
"N" Version, 1-Pole



Item Code	Rated Current	IEC/EN 60898-1 Household Application		IEC/EN 60947-2 Industrial Application	
		A	Icn at 230V (L-N)	Icu at 100-133V (L-N)	Icu at 100-133V (L-N)
SE-A9F74102	2A	6 kA	50 kA	50 kA	
SE-A9F74103	3A	6 kA	50 kA	50 kA	
SE-A9F74104	4A	6 kA	50 kA	50 kA	
SE-A9F74106	6A	6 kA	20 kA	10 kA	
SE-A9F74110	10A	6 kA	20 kA	10 kA	
SE-A9F74116	16A	6 kA	20 kA	10 kA	
SE-A9F74120	20A	6 kA	20 kA	10 kA	
SE-A9F74125	25A	6 kA	20 kA	10 kA	
SE-A9F74132	32A	6 kA	20 kA	10 kA	
SE-A9F74140	40A	6 kA	20 kA	10 kA	
SE-A9F74150	50A	6 kA	20 kA	10 kA	
SE-A9F74163	63A	6 kA	20 kA	10 kA	

iC60N (C-curve)
"N" Version, 2-Pole



Item Code	Rated Current	IEC/EN 60898-1 Household Application		IEC/EN 60947-2 Industrial Application		
		A	Icn at 230V (L-N) / 400V (L-L)	Icu at 220-240V (L-L)	Icu at 380-415V (L-L)	Icu at 440V (L-L)
SE-A9F74202	2A	6 kA	50 kA	50 kA	25 kA	
SE-A9F74203	3A	6 kA	50 kA	50 kA	25 kA	
SE-A9F74204	4A	6 kA	50 kA	50 kA	25 kA	
SE-A9F74206	6A	6 kA	20 kA	10 kA	6 kA	
SE-A9F74210	10A	6 kA	20 kA	10 kA	6 kA	
SE-A9F74216	16A	6 kA	20 kA	10 kA	6 kA	
SE-A9F74220	20A	6 kA	20 kA	10 kA	6 kA	
SE-A9F74225	25A	6 kA	20 kA	10 kA	6 kA	
SE-A9F74232	32A	6 kA	20 kA	10 kA	6 kA	
SE-A9F74240	40A	6 kA	20 kA	10 kA	6 kA	
SE-A9F74250	50A	6 kA	20 kA	10 kA	6 kA	
SE-A9F74263	63A	6 kA	20 kA	10 kA	6 kA	

iC60N (C-curve)
"N" Version, 3-Pole



Item Code	Rated Current	IEC/EN 60898-1 Household Application		IEC/EN 60947-2 Industrial Application		
		A	Icn at 230V (L-N) / 400V (L-L)	Icu at 220-240V (L-L)	Icu at 380-415V (L-L)	Icu at 440V (L-L)
SE-A9F74302	2A	6 kA	50 kA	50 kA	25 kA	
SE-A9F74303	3A	6 kA	50 kA	50 kA	25 kA	
SE-A9F74304	4A	6 kA	50 kA	50 kA	25 kA	
SE-A9F74306	6A	6 kA	20 kA	10 kA	6 kA	
SE-A9F74310	10A	6 kA	20 kA	10 kA	6 kA	
SE-A9F74316	16A	6 kA	20 kA	10 kA	6 kA	
SE-A9F74320	20A	6 kA	20 kA	10 kA	6 kA	
SE-A9F74325	25A	6 kA	20 kA	10 kA	6 kA	
SE-A9F74332	32A	6 kA	20 kA	10 kA	6 kA	
SE-A9F74340	40A	6 kA	20 kA	10 kA	6 kA	
SE-A9F74350	50A	6 kA	20 kA	10 kA	6 kA	
SE-A9F74363	63A	6 kA	20 kA	10 kA	6 kA	

Breakers

iC60H (C-curve)
"H" Version, 1-Pole



Item Code	Rated Current	IEC/EN 60898-1 Household Application		IEC/EN 60947-2 Industrial Application	
		A	Icn at 230V (L-N)	Icu at 100-133V (L-N)	Icu at 200-240V (L-N)
SE-A9F84102	2A	10 kA	70 kA	50 kA	
SE-A9F84103	3A	10 kA	70 kA	50 kA	
SE-A9F84104	4A	10 kA	70 kA	50 kA	
SE-A9F84106	6A	10 kA	15 kA	10 kA	
SE-A9F84110	10A	10 kA	15 kA	10 kA	
SE-A9F84116	16A	10 kA	15 kA	10 kA	
SE-A9F84120	20A	10 kA	15 kA	10 kA	
SE-A9F84125	25A	10 kA	15 kA	10 kA	
SE-A9F84132	32A	10 kA	15 kA	10 kA	
SE-A9F84140	40A	10 kA	15 kA	10 kA	
SE-A9F84150	50A	10 kA	15 kA	10 kA	
SE-A9F84163	63A	10 kA	15 kA	10 kA	

iC60H (C-curve)
"H" Version, 2-Pole



Item Code	Rated Current	IEC/EN 60898-1 Household Application		IEC/EN 60947-2 Industrial Application		
		A	Icn at 230V (L-N) / 400V (L-L)	Icu at 220-240V (L-L)	Icu at 380-415V (L-L)	Icu at 440V (L-L)
SE-A9F84202	2A	10 kA	70 kA	70 kA	50 kA	
SE-A9F84203	3A	10 kA	70 kA	70 kA	50 kA	
SE-A9F84204	4A	10 kA	70 kA	70 kA	50 kA	
SE-A9F84206	6A	10 kA	30 kA	15 kA	10 kA	
SE-A9F84210	10A	10 kA	30 kA	15 kA	10 kA	
SE-A9F84216	16A	10 kA	30 kA	15 kA	10 kA	
SE-A9F84220	20A	10 kA	30 kA	15 kA	10 kA	
SE-A9F84225	25A	10 kA	30 kA	15 kA	10 kA	
SE-A9F84232	32A	10 kA	30 kA	15 kA	10 kA	
SE-A9F84240	40A	10 kA	30 kA	15 kA	10 kA	
SE-A9F84250	50A	10 kA		15 kA	10 kA	
SE-A9F84263	63A	10 kA		15 kA	10 kA	

iC60H (C-curve)
"H" Version, 3-Pole



Item Code	Rated Current	IEC/EN 60898-1 Household Application		IEC/EN 60947-2 Industrial Application		
		A	Icn at 230V (L-N) / 400V (L-L)	Icu at 220-240V (L-L)	Icu at 380-415V (L-L)	Icu at 440V (L-L)
SE-A9F84302	2A	10 kA	70 kA	70 kA	50 kA	
SE-A9F84303	3A	10 kA	70 kA	70 kA	50 kA	
SE-A9F84304	4A	10 kA	70 kA	70 kA	50 kA	
SE-A9F84306	6A	10 kA	30 kA	15 kA	10 kA	
SE-A9F84310	10A	10 kA	30 kA	15 kA	10 kA	
SE-A9F84316	16A	10 kA	30 kA	15 kA	10 kA	
SE-A9F84320	20A	10 kA	30 kA	15 kA	10 kA	
SE-A9F84325	25A	10 kA	30 kA	15 kA	10 kA	
SE-A9F84332	32A	10 kA	30 kA	15 kA	10 kA	
SE-A9F84340	40A	10 kA	30 kA	15 kA	10 kA	
SE-A9F84350	50A	10 kA		15 kA	10 kA	
SE-A9F84363	63A	10 kA		15 kA	10 kA	

WIRING DEVICES



CERTIFIED
Product Safety
License No. Q-1422

Switches & Outlets

HIGH QUALITY. SAFE. **VALUE FOR MONEY.**

Designed to fit various interiors while providing safe and quality products at affordable price.



STEEL PLATE



Benefits:

- High Impact Resistance
- Flame Retardant
- High Heat Resistance Up to 120°C

Sets, Plates, and Outlets are also available with others colors:

- Dark Gray
- Dark Wood

3 way Switches
Typical for 2 & 3 Gang

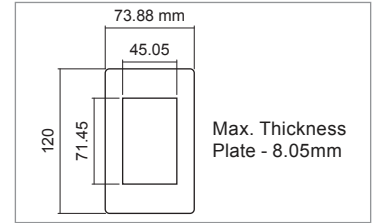

Sets & Plates

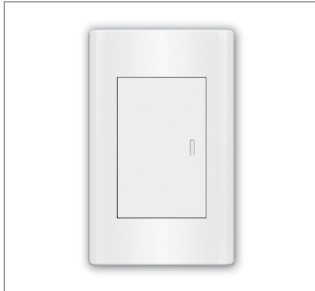

1 Gang Switch
MD511
250V~ 16A

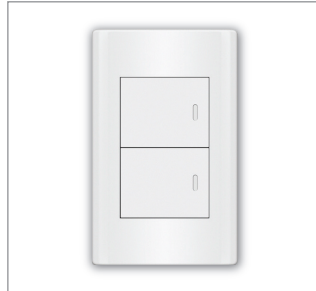

2 Gang Switch
MD513
250V~ 16A

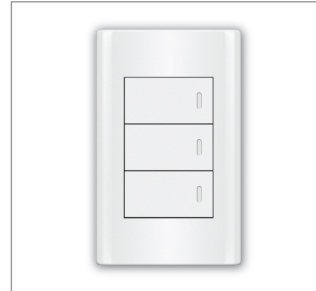

3 Gang Switch
MD515
250V~ 16A

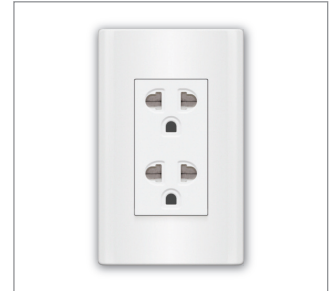

Duplex Universal Outlet
MD912
250V~ 16A

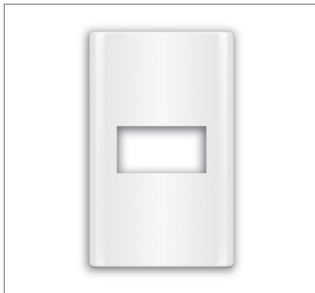

1 Gang Plate
RMP1

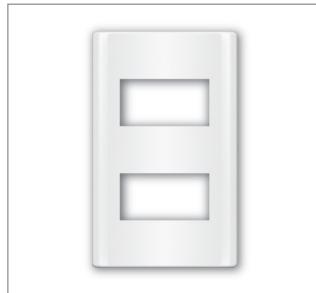

2 Gang Plate
RMP2

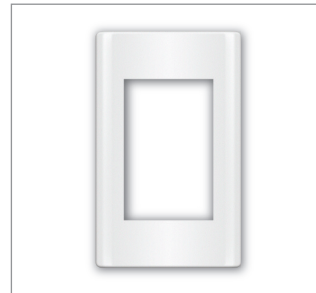

3 Gang Plate
RMP3

Components

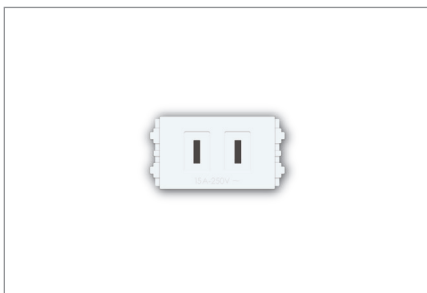

Flat Pin Outlet
RWO3
250V~ 16A

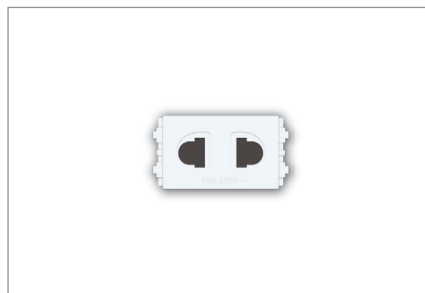

Universal Outlet
RWO6
250V~ 16A



Flat Pin Outlet with Ground
RWO7
250V~ 16A



Telephone Modular Jack
RWX1



Cable TV Socket
RWX2



LAN Outlet
RWX3



Benefits:

- High Impact Resistance
- Flame Retardant
- High Heat Resistance Up to 120°C

1 way Switches
Typical for 2 & 3 Gang

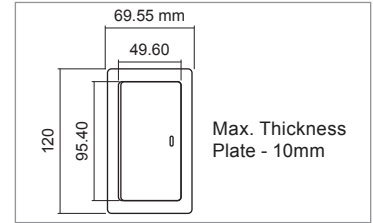

Sets & Plates



1 Gang Switch
WS511
250V~ 10A



2 Gang Switch
WS513
250V~ 10A



3 Gang Switch
WS515
250V~ 10A

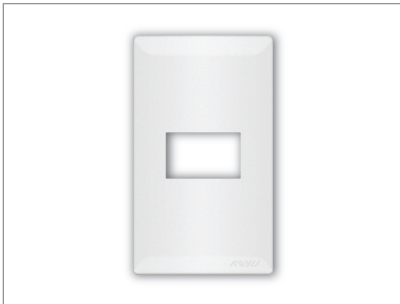

1 Gang Plate
RSP1

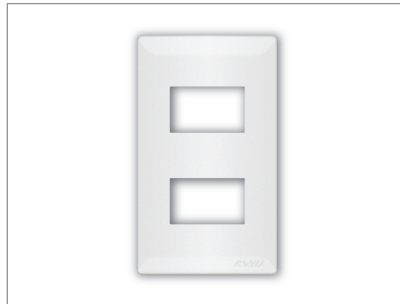

2 Gang Plate
RSP2

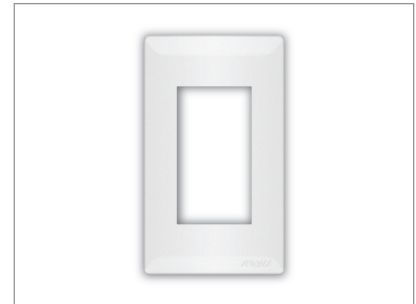

3 Gang Plate
RSP3



2 Gang Universal Outlet
WS113
250V~ 10A



3 Gang Universal Outlet
WS115
250V~ 10A

Wiring Devices







Sets & Plates

					
1 Gang Switch with Reflector WD511, 250V~ 10A	2 Gang Switch with Reflector WD513, 250V~ 10A	3 Gang Switch with Reflector WD515, 250V~ 10A	1 Gang Switch with LED Set WD601, 250V~ 10A	2 Gang Switch with LED Set WD603, 250V~ 10A	3 Gang Switch with LED Set WD605, 250V~ 10A
					
1 Gang 3-Way Switch Set WD701, 250V~ 10A	2 Gang 3-Way Switch Set WD703, 250V~ 10A	1 Gang Doorbell Switch WD801, 250V~ 10A	1 Gang Universal Outlet Set WD111, 250V~ 10A	2 Gang Universal Outlet Set WD113, 250V~ 10A	3 Gang Universal Outlet Set WD115, 250V~ 10A
					
1 Gang Aircon Outlet Set WD901, 250V~ 20A	Duplex Flat Pin Outlet with Ground WD922, 250V~ 16A	Duplex GFCI Outlet Set WD932, 250V~ 16A	1 Gang Telephone Modular Jack WD211	2 Gang Telephone Modular Jack WD213	1 Gang TV Terminal WD311
					
1 Gang Plate RWP1	2 Gang Plate RWP2	3 Gang Plate RWP3	1 Gang Plate for Universal Outlet with Ground RWP8	Blank Plate RWP4	Weather-Proof Plate Cover Slim Type RWP6





Components

				
1 Way Switch-A RWS1-A, RWS6-A 250V~	1 Way Switch-A with LED RWS7-A, 250V~ 16A	1 Way Switch-B RWS1-B, 250V~ 10A	1 Way Switch-C RWS1-C, 250V~ 10A	3 Way Switch RWS3, 250V~ 10A
				
Doorbell Switch RWS4, 250V~ 10A	Dimmer Switch RWS5-A, 250V~ 10A RWS5-C, 250V~ 10A	Universal Outlet RWO1, 250V~	Outlet with Ground RWO2, 250V~	Duplex Flat Pin Outlet with Ground RWO5, 250V~ 16A
				
Universal Outlet with Ground RWO8, 250V~ 10A	USB Outlet RWO9, 5V 2100mA	Telephone Outlet Box ROBT1	Doorbell Small RDOR1	Doorbell Big RDOR2









Sets & Plates

						
1 Gang Switch WH501 250V~ 10A	2 Gang Switch WH503 250V~ 10A	3 Gang Switch WH505 250V~ 10A	1 Gang Switch with LED Set WH601 250V~ 10A	2 Gang Switch with LED Set WH603 250V~ 10A	3 Gang Switch with LED Set WH605 250V~ 10A	1 Gang 3-Way Switch Set WH701 250V~ 10A
						
2 Gang 3-Way Switch Set WH703 250V~ 10A	1 Gang Doorbell Switch WH801 250V~ 10A	1 Gang Doorbell Switch WH811 250V~ 10A	1 Gang Outlet Set WH111 250V~ 10A	2 Gang Outlet Set WH813 250V~ 10A	3 Gang Outlet Set WH115 250V~ 10A	1 Gang Aircon Outlet Set WH901 250V~ 20A
						
Duplex Flat Pin Outlet w/ Ground WH922 250V~ 16A	Duplex GFCI Outlet Set WH932 250V~ 16A	Flush Mount Power Receptacle WH941/SL 250V~ 30A	1 Gang Telephone Modular Jack WH211	2 Gang Telephone Modular Jack WH213	1 Gang TV Terminal Set WH311	1 Gang Plate RCP1
						
2 Gang Plate RCP2	3 Gang Plate RCP3	Blank Plate RCP4	Weather-Proof Plate Cover RCP5	Weather-Proof Plate Cover Slim Type RCP6		

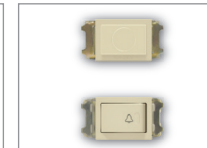
Floor Receptacles

			
Round Floor Receptacle Bronze RCF1	Square Floor Receptacle Bronze RCF2	Round Floor Receptacle Zinc RCF3	Square Floor Receptacle Zinc RCF4

Components

					
1 Way Switch without LED RCS1, RCS6, 250V~	1 Way Switch with LED RCS2, RCS7, 250V~	3 Way Switch RCS3 250V~ 10A	Doorbell Switch RCS4, RCS4-A 250V~ 10A	Dimmer Switch RCS5-A, RCS5-B, RCS5-C, 250V~ 10A	Universal Outlet RC01, RC06 250V~
					
Outlet with Ground RC02, RC07 250V~	Flat Pin Outlet RCO3, 250V~ 16A	Duplex Flat Pin with Ground RCO5, 250V~ 16A	Telephone Modular Jack RCX1	Cable TV Socket RCX2	LAN Outlet RCX3

Wiring Devices

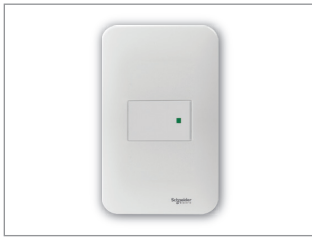

1 Gang 1 Way Switch
SE-CA_FS1W1GS_SA
Standard, 16A



2 Gang 1 Way Switch
SE-CA_FS1W2GS_SA
Standard, 16A



3 Gang 1 Way Switch
SE-CA_FS1W3GS_SA
Standard, 16A



4 Gang 1 Way Switch
SE-CA_FS1W4GXS_SA
XS Size, 16A



1 Gang 1 Way Switch
SE-CA_FS1W1GL_SA
Elongated, 16A



2 Gang 1 Way Switch
SE-CA_FS1W2GM_SA
Mid Size, 16A

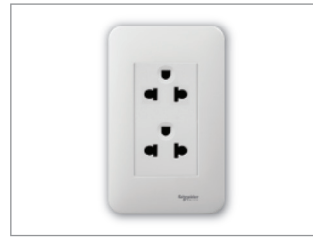

Duplex 3-pin Universal Outlet
SE-CA_FS2GT3P_OA
16A

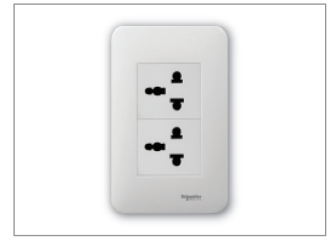

2 Gang International Outlet
SE-CA_FSTIP_OA
13A



Co-axial Outlet Mechanism Assembly
SE-CA_FSCOAX_MA



Telephone Outlet Mechanism Assembly
SE-CA_FSTEL_MA



Data Outlet Mechanism Assembly
SE-CA_FSDAT_MA

Schneider Electric Concept Series - Sets



1 Gang 1 Way Switch
SE-CA_CCS3031_1GAF
Standard, 16A



2 Gang 1 Way Switch
SE-CA_CCS3031_2GAF
Standard, 16A



3 Gang 1 Way Switch
SE-CA_CCS3031_3GAF
Standard, 16A



1 Gang 1 Way Switch
SE-CA_CCS3031E1_AF
Elongated, 16A



2 Gang 1 Way Switch
SE-CA_CCS3031M1_AF
Mid Size, 16A



Duplex 3 Pin Universal Outlet
SE-CA_CCS3045SAT3P
16A



Duplex 2 Pin Universal Outlet
SE-CA_CCS3043SA_2P
16A

LIGHTING SOLUTIONS



LED Tube



LED Ceiling Lamp



LED Downlight



LED Grille Light



LED Floodlight



LED Slim Canopy

LIVING ROOM / DINING



FFS02T8DL12

LED Tube

BRIGHT. LONG-LASTING. EFFICIENT.

Provides the right amount of brightness but more energy-efficient to replace conventional CFL. Easy and safe to use whether for retrofitting or new installations.

FFS02T8DL12

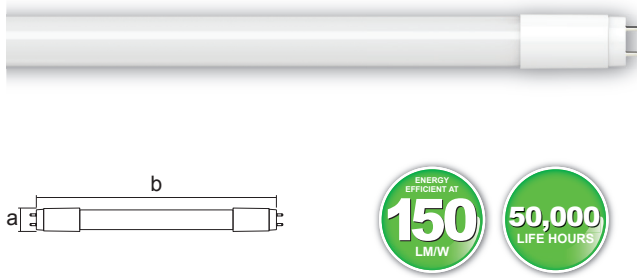

Light Distribution Curve

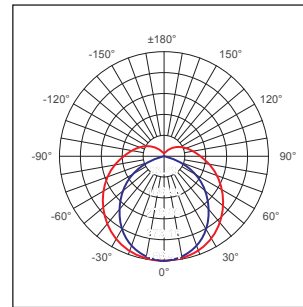

Lux Distance Curve

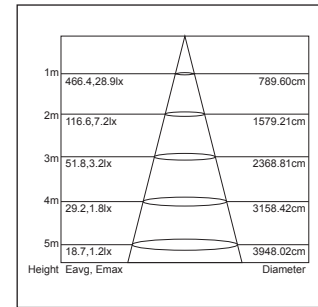

Item Code	Wattage	Lumen Output	Operating Voltage	Life Hours	Color Temperature	Beam Angle	CRI	Dimmable	Lamp Base	Dimensions
	W	Lm	V	Hrs.	K	°		Yes/No		(a x b mm)
FFS02T8DL12	12	1800	100-277	50,000	6500 • Daylight	180	≥ 83	no	G13	28 x 1205.3
FFS02T8CW12	12	1800	100-277	50,000	5000 • Cool White	180	≥ 83	no	G13	28 x 1205.3

F2LST8DL18

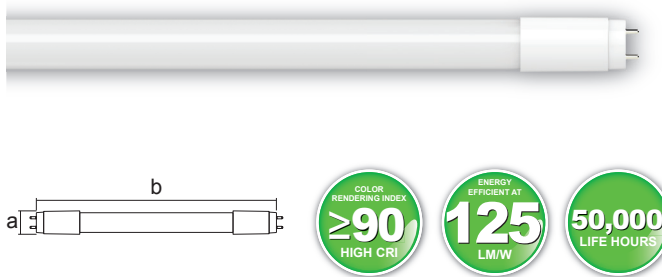

Light Distribution Curve

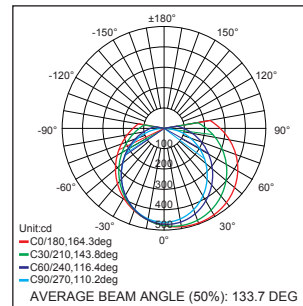

Lux Distance Curve

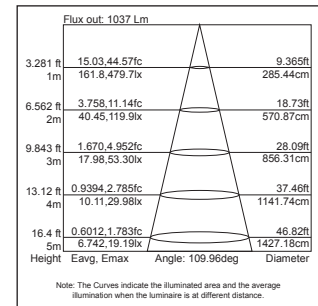

Item Code	Wattage	Lumen Output	Operating Voltage	Life Hours	Color Temperature	Beam Angle	CRI	Dimmable	Lamp Base	Dimensions
	W	Lm	V	Hrs.	K	°		Yes/No		(a x b mm)
F2LST8DL09	9	1125	198-277	50,000	6500 • Daylight	200	≥ 90	no	G13	28 x 595.7
F2LST8DL18	18	2250	198-277	50,000	6500 • Daylight	200	≥ 90	no	G13	28 x 1205.3

LFS03T8DL18

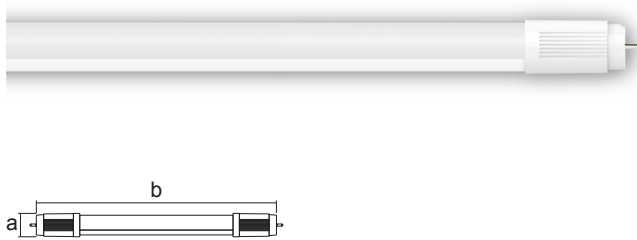

Light Distribution Curve

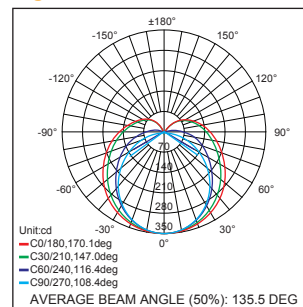

Lux Distance Curve

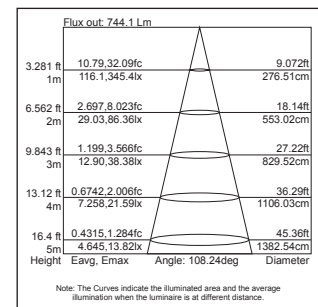

Item Code	Wattage	Lumen Output	Operating Voltage	Life Hours	Color Temperature	Beam Angle	CRI	Dimmable	Lamp Base	Dimensions
	W	Lm	V	Hrs.	K	°		Yes/No		(a x b mm)
LFS03T8DL09	9	900	100-277	30,000	6500 • Daylight	200	≥ 80	no	G13	25.4 x 600
LFS03T8WW09	9	850	100-277	30,000	3000 • Warm White	200	≥ 80	no	G13	25.4 x 600
LFS03T8CW09	9	850	100-277	30,000	4000 • Cool White	200	≥ 80	no	G13	25.4 x 600
LFS03T8DL18	18	1800	100-277	30,000	6500 • Daylight	200	≥ 80	no	G13	25.4 x 1200
LFS03T8WW18	18	1750	100-277	30,000	3000 • Warm White	200	≥ 80	no	G13	25.4 x 1200
LFS03T8CW18	18	1750	100-277	30,000	4000 • Cool White	200	≥ 80	no	G13	25.4 x 1200

Living Room / Dining

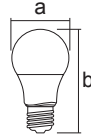

FBI210DL

Light Distribution Curve

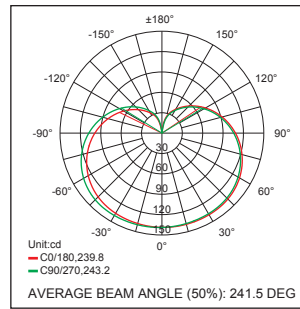

Lux Distance Curve

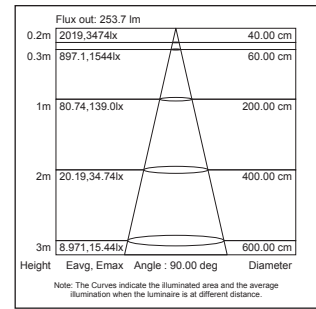

Item Code	Wattage	Lumen Output	Operating Voltage	Life Hours	Color Temperature	Beam Angle	CRI	Dimmable	Lamp Base	Dimensions
	W	Lm	V	Hrs.	K	°		Yes/No		(a x b mm)
FBI206DL	6	600	100-240	30,000	6500 • Daylight	200	≥ 80	no	E27	60 x 110
FBI206WW	6	550	100-240	30,000	3000 • Warm White	200	≥ 80	no	E27	60 x 110
FBI206CW	6	550	100-240	30,000	4000 • Cool White	200	≥ 80	no	E27	60 x 110
FBI210DL	10	1030	100-240	30,000	6500 • Daylight	200	≥ 80	no	E27	60 x 120
FBI210WW	10	1000	100-240	30,000	3000 • Warm White	200	≥ 80	no	E27	60 x 120
FBI210CW	10	1000	100-240	30,000	4000 • Cool White	200	≥ 80	no	E27	60 x 120
FBI214DL	14	1400	100-240	30,000	6500 • Daylight	200	≥ 80	no	E27	67 x 145
FBI214WW	14	1320	100-240	30,000	3000 • Warm White	200	≥ 80	no	E27	67 x 145
FBI214CW	14	1320	100-240	30,000	4000 • Cool White	200	≥ 80	no	E27	67 x 145
FBI218DL	18	2000	220-240	30,000	6500 • Daylight	230	≥ 80	no	E27	67 x 147
FBI220DL	20	2300	220-240	30,000	6500 • Daylight	230	≥ 80	no	E27	67 x 147
FBI609WW	9	800	220-240	25,000	3000 • Warm White	200	≥ 80	yes	E27	60 x 110

FIREFLY PRO Series Tri-Color



TRI-COLOR

Switch from Warm White to Daylight to Cool White with a flick of a switch.

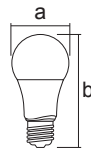

FBF508TC

Light Distribution Curve

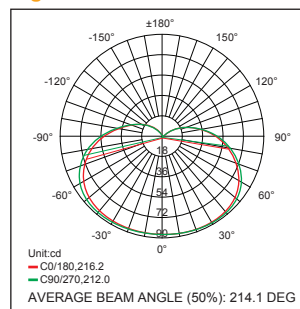

Lux Distance Curve

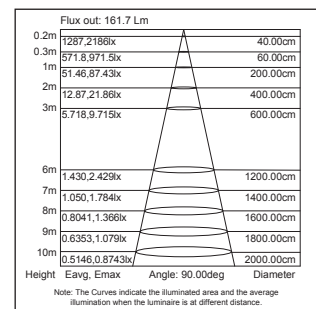

Item Code	Wattage	Lumen Output	Operating Voltage	Life Hours	Color Temperature	Beam Angle	CRI	Dimmable	Lamp Base	Dimensions
	W	Lm	V	Hrs.	K	°		Yes/No		(a x b mm)
FBF508TC	8	806	100-240	25,000	2700 • Warm White 6500 • Daylight 4000 • Cool White	230	≥ 80	no	E27	60 x 120

EFS03T8DL18

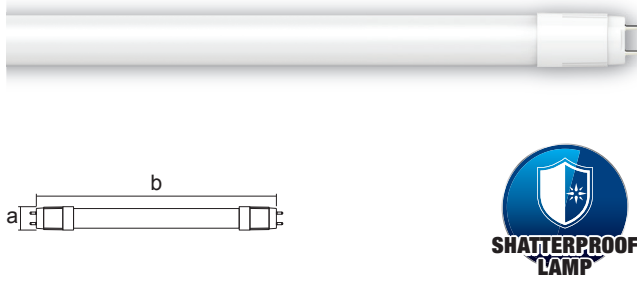

Light Distribution Curve

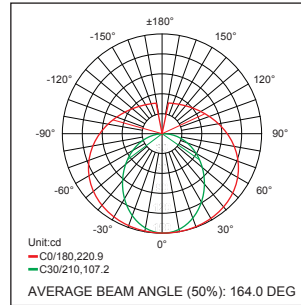

Lux Distance Curve

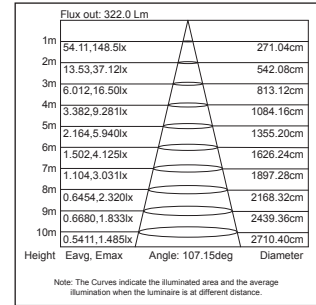

Item Code	Wattage	Lumen Output	Operating Voltage	Life Hours	Color Temperature	Beam Angle	CRI	Dimmable	Lamp Base	Dimensions
	W	Lm	V	Hrs.	K	°		Yes/No		(a x b mm)
EFS03T8DL09	9	800	100-240	15,000	6500 • Daylight	200	≥ 80	no	G13	25.4 x 600
EFS03T8DL18	18	1650	100-240	15,000	6500 • Daylight	200	≥ 80	no	G13	25.4 x 1200

EFS04T8DL18

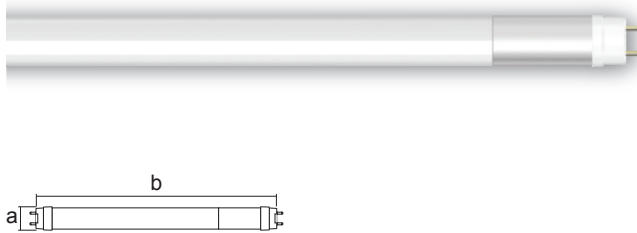

Light Distribution Curve

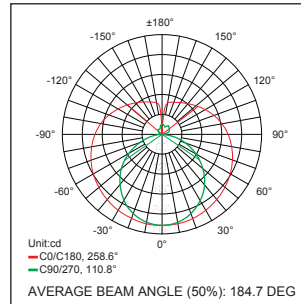

Lux Distance Curve

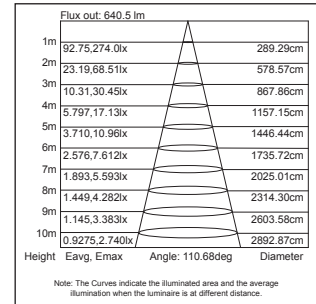

Item Code	Wattage	Lumen Output	Operating Voltage	Life Hours	Color Temperature	Beam Angle	CRI	Dimmable	Lamp Base	Dimensions
	W	Lm	V	Hrs.	K	°		Yes/No		(a x b mm)
EFS04T8DL09	9	800	220-240	15,000	6500 • Daylight	180	≥ 80	no	G13	25.4 x 600
EFS04T8DL18	18	1650	220-240	15,000	6500 • Daylight	180	≥ 80	no	G13	25.4 x 1200

Living Room / Dining

EBTS11/DL18

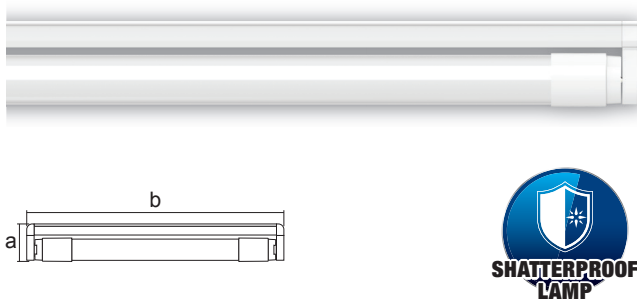

Light Distribution Curve

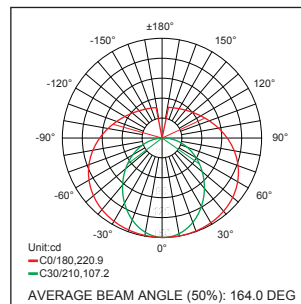

Lux Distance Curve

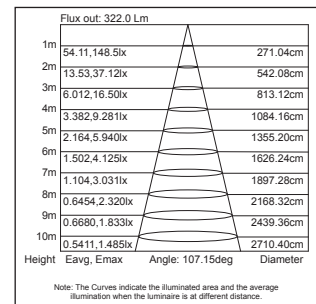

Item Code	Wattage	Lumen Output	Operating Voltage	Life Hours	Color Temperature	Beam Angle	CRI	Dimmable	Lamp Base	Dimensions
	W	Lm	V	Hrs.	K	°		Yes/No		(a x b mm)
EBTS11/DL09	9	800	100-240	15,000	6500 • Daylight	200	≥ 80	no	G13	43 x 606
EBTS11/DL18	18	1650	100-240	15,000	6500 • Daylight	200	≥ 80	no	G13	43 x 1222

EDL112603DL

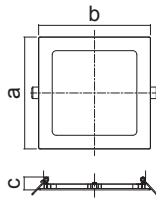
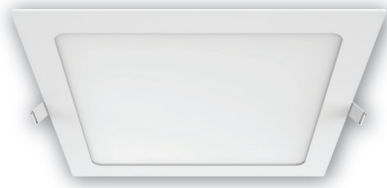

Light Distribution Curve

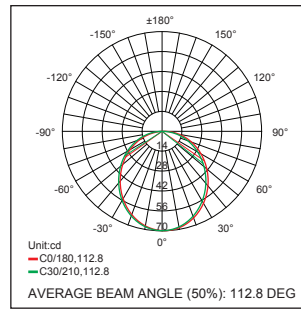

Lux Distance Curve

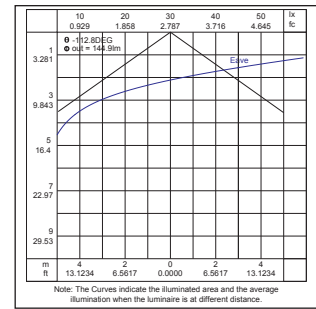

Item Code	Wattage	Lumen Output	Operating Voltage	Life Hours	Color Temperature	Beam Angle	CRI	Dimmable	Dimensions	Cut-out Size
	W	Lm	V	Hrs.	K	°		Yes/No	(a x b x c mm)	(mm)
EDL112603DL	3	180	100-240	25,000	6500 • Daylight	110	≥ 80	no	80 x 80 x 24	75 x 75
EDL112603WW	3	180	100-240	25,000	3000 • Warm White	110	≥ 80	no	80 x 80 x 24	75 x 75
EDL112606DL	6	360	100-240	25,000	6500 • Daylight	110	≥ 80	no	115 x 115 x 19	100 x 100
EDL112606WW	6	320	100-240	25,000	3000 • Warm White	110	≥ 80	no	115 x 115 x 19	100 x 100
EDL112612DL	12	800	100-240	25,000	6500 • Daylight	110	≥ 80	no	165 x 165 x 19	150 x 150
EDL112612WW	12	720	100-240	25,000	3000 • Warm White	110	≥ 80	no	165 x 165 x 19	150 x 150
EDL112618DL	18	1300	100-240	25,000	6500 • Daylight	110	≥ 80	no	215 x 215 x 19	200 x 200

FIREFLY BASIC Series LED Recessed Slim Downlight

EDL212606DL

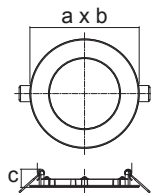

Light Distribution Curve

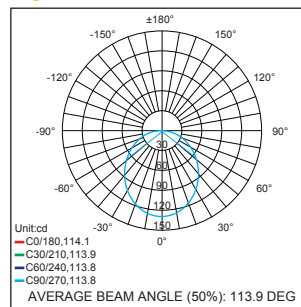

Lux Distance Curve

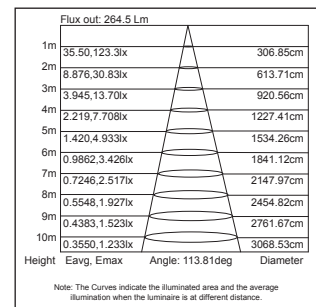

Item Code	Wattage	Lumen Output	Operating Voltage	Life Hours	Color Temperature	Beam Angle	CRI	Dimmable	Dimensions	Cut-out Size
	W	Lm	V	Hrs.	K	°		Yes/No	(a x b mm)	(mm)
EDL212603DL	3	180	100-240	25,000	6500 • Daylight	110	≥ 80	no	Ø 80 x 24	Ø 75
EDL212603WW	3	180	100-240	25,000	3000 • Warm White	110	≥ 80	no	Ø 80 x 24	Ø 75
EDL212606DL	6	360	100-240	25,000	6500 • Daylight	110	≥ 80	no	Ø 115 x 19	Ø 100
EDL212606WW	6	320	100-240	25,000	3000 • Warm White	110	≥ 80	no	Ø 115 x 19	Ø 100
EDL212612DL	12	800	100-240	25,000	6500 • Daylight	110	≥ 80	no	Ø 165 x 19	Ø 150
EDL212612WW	12	720	100-240	25,000	3000 • Warm White	110	≥ 80	no	Ø 165 x 19	Ø 150
EDL212618DL	18	1300	100-240	25,000	6500 • Daylight	110	≥ 80	no	Ø 215 x 19	Ø 200

EDL113612DL

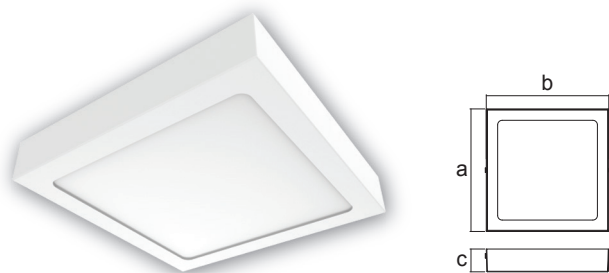

Light Distribution Curve

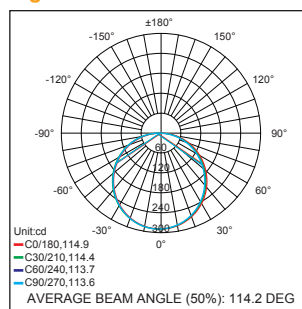

Lux Distance Curve

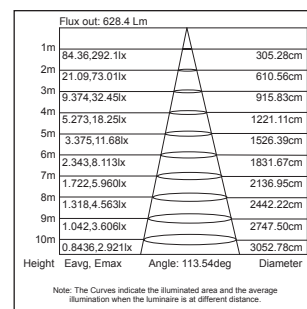

Item Code	Wattage	Lumen Output	Operating Voltage	Life Hours	Color Temperature	Beam Angle	CRI	Dimmable	Dimensions
	W	Lm	V	Hrs.	K	°		Yes/No	(a x b x c mm)
EDL113606DL	6	360	100-240	25,000	6500 • Daylight	110	≥ 80	no	115 x 115 x 35
EDL113606WW	6	320	100-240	25,000	3000 • Warm White	110	≥ 80	no	115 x 115 x 35
EDL113612DL	12	800	100-240	25,000	6500 • Daylight	110	≥ 80	no	165 x 165 x 35
EDL113612WW	12	720	100-240	25,000	3000 • Warm White	110	≥ 80	no	165 x 165 x 35
EDL113618DL	18	1300	100-240	25,000	6500 • Daylight	110	≥ 80	no	215 x 215 x 35
EDL113618WW	18	1300	100-240	25,000	3000 • Warm White	110	≥ 80	no	215 x 215 x 35

FIREFLY BASIC Series LED Surface Slim Downlight



EDL213618DL

Light Distribution Curve

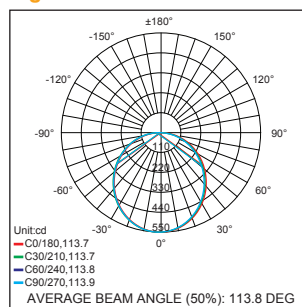

Lux Distance Curve

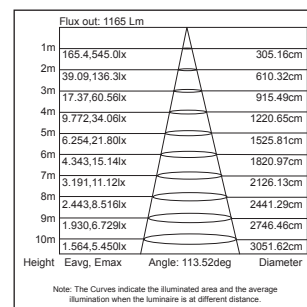

Item Code	Wattage	Lumen Output	Operating Voltage	Life Hours	Color Temperature	Beam Angle	CRI	Dimmable	Dimensions
	W	Lm	V	Hrs.	K	°		Yes/No	(a x b x c mm)
EDL213606DL	6	360	100-240	25,000	6500 • Daylight	110	≥ 80	no	Ø 115 x 35
EDL213606WW	6	320	100-240	25,000	3000 • Warm White	110	≥ 80	no	Ø 115 x 35
EDL213612DL	12	800	100-240	25,000	6500 • Daylight	110	≥ 80	no	Ø 165 x 35
EDL213612WW	12	720	100-240	25,000	3000 • Warm White	110	≥ 80	no	Ø 165 x 35
EDL213618DL	18	1300	100-240	25,000	6500 • Daylight	110	≥ 80	no	Ø 215 x 35
EDL213618WW	18	1300	100-240	25,000	3000 • Warm White	110	≥ 80	no	Ø 215 x 35

Living Room / Dining

EDL222209DL

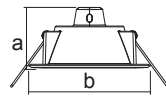

Light Distribution Curve

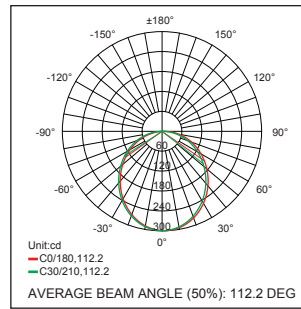

Lux Distance Curve

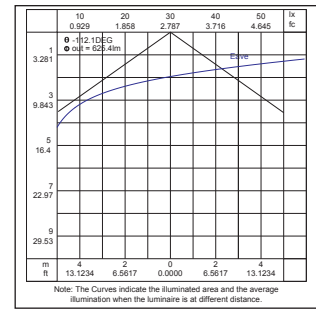

Item Code	Wattage	Lumen Output	Operating Voltage	Life Hours	Color Temperature	Beam Angle	CRI	Dimmable	Dimensions	Cut-out Size
	W	Lm	V	Hrs.	K	°		Yes/No	(a x b mm)	(mm)
EDL222203DL	3	270	100-240	20,000	6500 • Daylight	90	≥ 80	no	Ø 92 x 50	Ø 75
EDL222203WW	3	250	100-240	20,000	3000 • Warm White	90	≥ 80	no	Ø 92 x 50	Ø 75
EDL222206DL	6	540	100-240	20,000	6500 • Daylight	90	≥ 80	no	Ø 92 x 50	Ø 75
EDL222206WW	6	500	100-240	20,000	3000 • Warm White	90	≥ 80	no	Ø 92 x 50	Ø 75
EDL222209DL	9	810	100-240	20,000	6500 • Daylight	90	≥ 80	no	Ø 112 x 50	Ø 100
EDL222209WW	9	750	100-240	20,000	3000 • Warm White	90	≥ 80	no	Ø 112 x 50	Ø 100
EDL222212DL	12	1080	100-240	20,000	6500 • Daylight	90	≥ 80	no	Ø 166 x 54	Ø 150
EDL222212WW	12	1000	100-240	20,000	3000 • Warm White	90	≥ 80	no	Ø 166 x 54	Ø 150
EDL222215DL	15	1350	100-240	20,000	6500 • Daylight	90	≥ 80	no	Ø 166 x 54	Ø 150
EDL222215WW	15	1250	100-240	20,000	3000 • Warm White	90	≥ 80	no	Ø 166 x 54	Ø 150

FIREFLY BASIC Series LED Regular Downlight

EDL2519DL

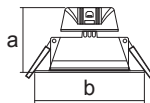

Light Distribution Curve

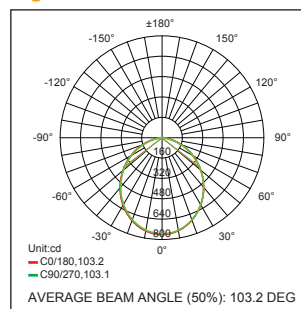

Lux Distance Curve

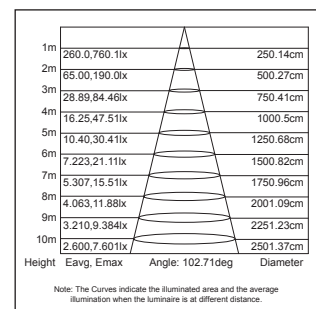

Item Code	Wattage	Lumen Output	Operating Voltage	Life Hours	Color Temperature	Beam Angle	CRI	Dimmable	Dimensions	Cut-out Size
	W	Lm	V	Hrs.	K	°		Yes/No	(a x b mm)	(mm)
EDL2508DL	8	800	100-240	20,000	6500 • Daylight	100	≥ 80	no	68.5 x Ø 115	Ø 90 - Ø 102
EDL2509DL	9	900	100-240	20,000	6500 • Daylight	100	≥ 80	no	78.5 x Ø 145	Ø 120 - Ø 130
EDL2512DL	12	1200	100-240	20,000	6500 • Daylight	100	≥ 80	no	84.5 x Ø 197	Ø 145 - Ø 155
EDL2519DL	19	1900	100-240	20,000	6500 • Daylight	100	≥ 80	no	98.5 x Ø 245	Ø 195 - Ø 210

*Cut-out: Same size as traditional Downlight fixtures

EBTST5DL316

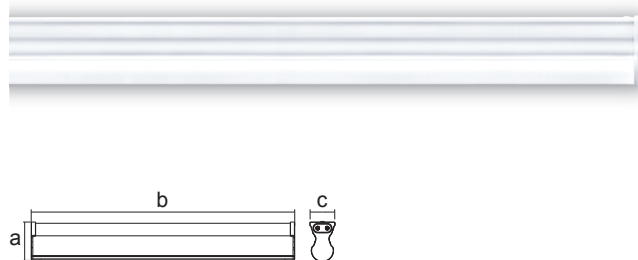

Light Distribution Curve

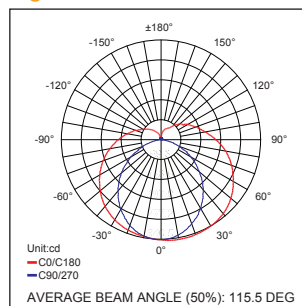

Lux Distance Curve

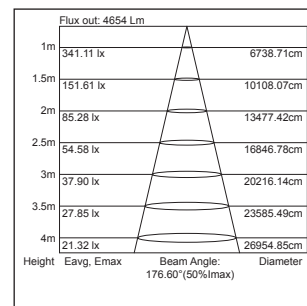

Item Code	Wattage	Lumen Output	Operating Voltage	Life Hours	Color Temperature	Beam Angle	CRI	Dimmable	Dimensions
	W	Lm	V	Hrs.	K	°		Yes/No	(a x b x c mm)
EBTST5DL305	5	400	165-250	15,000	6500 • Daylight	180	≥ 80	no	34.3 x 315 x 22
EBTST5WW305	5	350	165-250	15,000	3000 • Warm White	180	≥ 80	no	34.3 x 315 x 22
EBTST5CW305	5	400	165-250	15,000	4000 • Cool White	180	≥ 80	no	34.3 x 315 x 22
EBTST5DL308	8	700	165-250	15,000	6500 • Daylight	180	≥ 80	no	34.3 x 575 x 22
EBTST5WW308	8	650	165-250	15,000	3000 • Warm White	180	≥ 80	no	34.3 x 575 x 22
EBTST5CW308	8	700	165-250	15,000	4000 • Cool White	180	≥ 80	no	34.3 x 575 x 22
EBTST5DL314	14	1200	165-250	15,000	6500 • Daylight	180	≥ 80	no	34.3 x 1024 x 22
EBTST5WW314	14	1100	165-250	15,000	3000 • Warm White	180	≥ 80	no	34.3 x 1024 x 22
EBTST5CW314	14	1200	165-250	15,000	4000 • Cool White	180	≥ 80	no	34.3 x 1024 x 22
EBTST5DL316	16	1500	165-250	15,000	6500 • Daylight	180	≥ 80	no	34.3 x 1175 x 22
EBTST5WW316	16	1400	165-250	15,000	3000 • Warm White	180	≥ 80	no	34.3 x 1175 x 22
EBTST5CW316	16	1500	165-250	15,000	4000 • Cool White	180	≥ 80	no	34.3 x 1175 x 22

FIREFLY BASIC Series UFO Ceiling Lamp



Item Code	Wattage	Lumen Output	Operating Voltage	Life Hours	Color Temperature	Beam Angle	CRI	Dimmable	Lamp Base	Dimensions
	W	Lm	V	Hrs.	K	°		Yes/No		(∅ a x b mm)
ECL415DL	15	1200	220	15,000	6500 • Daylight	120	≥ 80	no	E27	150 x 80
ECL420DL	20	1600	220	15,000	6500 • Daylight	120	≥ 80	no	E27	200 x 80

Living Room / Dining

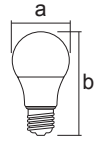

EBI109DL

Light Distribution Curve

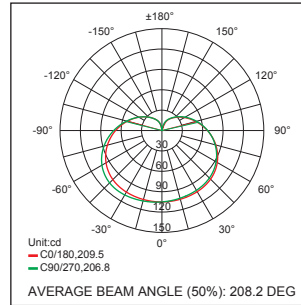

Lux Distance Curve

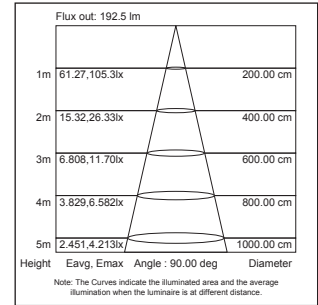

Item Code	Wattage	Lumen Output	Operating Voltage	Life Hours	Color Temperature	Beam Angle	CRI	Dimmable	Lamp Base	Dimensions
	W	Lm	V	Hrs.	K	°		Yes/No		(a x b mm)
EBI103DL	3	270	100-240	15,000	6500 • Daylight	200	≥ 80	no	E27	45 x 75
EBI103WW	3	250	100-240	15,000	3000 • Warm White	200	≥ 80	no	E27	45 x 75
EBI103CW	3	250	100-240	15,000	4000 • Cool White	200	≥ 80	no	E27	45 x 75
EBI105DL	5	400	100-240	15,000	6500 • Daylight	200	≥ 80	no	E27	60 x 110
EBI105WW	5	380	100-240	15,000	3000 • Warm White	200	≥ 80	no	E27	60 x 110
EBI105CW	5	380	100-240	15,000	4000 • Cool White	200	≥ 80	no	E27	60 x 110
EBI107DL	7	610	100-240	15,000	6500 • Daylight	200	≥ 80	no	E27	60 x 110
EBI107WW	7	550	100-240	15,000	3000 • Warm White	200	≥ 80	no	E27	60 x 110
EBI107CW	7	550	100-240	15,000	4000 • Cool White	200	≥ 80	no	E27	60 x 110
EBI109DL	9	806	100-240	15,000	6500 • Daylight	200	≥ 80	no	E27	60 x 110
EBI109WW	9	760	100-240	15,000	3000 • Warm White	200	≥ 80	no	E27	60 x 110
EBI109CW	9	760	100-240	15,000	4000 • Cool White	200	≥ 80	no	E27	60 x 110
EBI111DL	11	1060	100-240	15,000	6500 • Daylight	200	≥ 80	no	E27	60 x 117
EBI111WW	11	980	100-240	15,000	3000 • Warm White	200	≥ 80	no	E27	60 x 117
EBI113DL	13	1200	100-240	15,000	6500 • Daylight	200	≥ 80	no	E27	60 x 122
EBI115DL	15	1521	170-240	15,000	6500 • Daylight	200	≥ 80	no	E27	67 x 143
EBI118DL	18	1850	220-240	15,000	6500 • Daylight	230	≥ 80	no	E27	67 x 143
EBI120DL	20	2000	220-240	15,000	6500 • Daylight	230	≥ 80	no	E27	67 x 143

FIREFLY MR16 Downlight Fixtures

Fixed MR16 Fixture
with GU10 Lampholder



- Color : Sandy White Matte
- Material : CNC Aluminum - Powder-coated

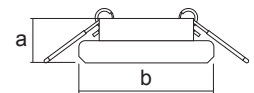

Item Code	Shape	Dimensions	Cut-out Size
		(a x b mm)	(mm)
FD201WH	Round	26 x 79	Ø 60

Tilttable MR16 Fixture
with GU10 Lampholder



- Color : Sandy White Matte
- Material : CNC Aluminum - Powder-coated

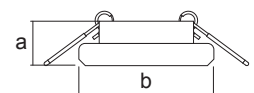

Item Code	Shape	Dimensions	Cut-out Size
		(a x b mm)	(mm)
FD202WH	Round	27 x 83	Ø 70



Tiltable MR16 Fixture
with GU10 Lampholder

- Color : Sandy White Matte
- Material : CNC Aluminum - Powder-coated

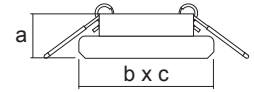

Item Code	Shape	Dimensions	Cut-out Size
		(a x b x c mm)	(mm)
FD203WH	Square	35 x 83 x 83	Ø 70



Low Glare MR16 Fixture
with GU10 Lampholder

- Color : Sandy White Matte
- Material : CNC Aluminum - Powder-coated

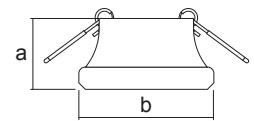

Item Code	Shape	Dimensions	Cut-out Size
		(a x b mm)	(mm)
FD204WH	Round	55 x 84	Ø 76



Low Glare MR16 Fixture
with GU10 Lampholder

- Color : Sandy White Matte
- Material : Die-cast Aluminum - Powder-coated

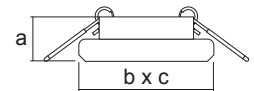

Item Code	Shape	Dimensions	Cut-out Size
		(a x b x c mm)	(mm)
FD205WH	Square	45 x 90 x 90	Ø 76



Twin MR16 Fixture
with GU10 Lampholder

- Color : Sandy White Matte
- Material : CNC Aluminum - Powder-coated

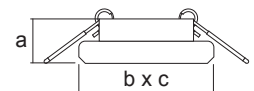

Item Code	Shape	Dimensions	Cut-out Size
		(a x b x c mm)	(mm)
FD208WH	Rectangular	28 x 92 x 185	170 x 80

LIVING ROOM / DINING

DECORATIVE



Filamentled
CLASSIC
EBI906WW

Filament Decorative

BRIGHT. LONG-LASTING. INNOVATIVE.

Create your desired warm white light ambiance in a classic design fit with your decorative needs.

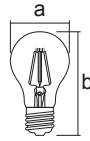

EBI909WW

Light Distribution Curve

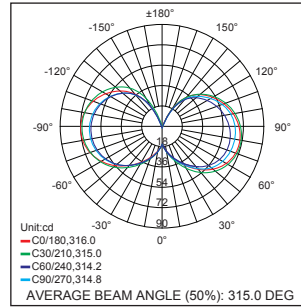

Lux Distance Curve

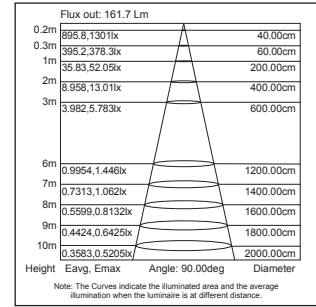

Item Code	Wattage	Lumen Output	Operating Voltage	Life Hours	Color Temperature	Beam Angle	CRI	Dimmable	Lamp Base	Dimensions
	W	Lm	V	Hrs.	K	°		Yes/No		(a x b mm)
EBI904WW	4	470	220-240	15,000	2700 • Warm White	320	≥80	no	E27	60 x 105
EBI906WW	6	806	220-240	15,000	2700 • Warm White	320	≥80	no	E27	60 x 105
EBI909WW	9	1060	220-240	15,000	2700 • Warm White	320	≥80	no	E27	60 x 105

FIREFLY BASIC Series Filament LED Mini Classic

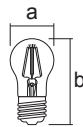

EBI904WW/1

Light Distribution Curve

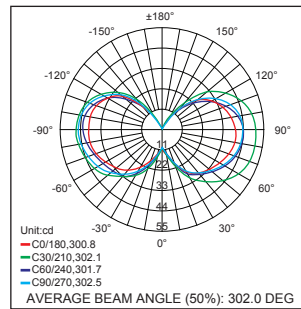

Lux Distance Curve

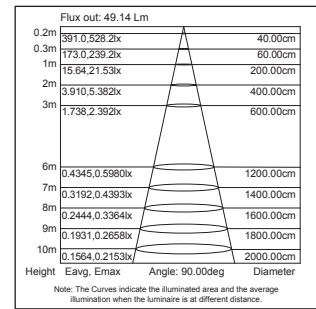

Item Code	Wattage	Lumen Output	Operating Voltage	Life Hours	Color Temperature	Beam Angle	CRI	Dimmable	Lamp Base	Dimensions
	W	Lm	V	Hrs.	K	°		Yes/No		(a x b mm)
EBI904WW/1	4	450	220-240	15,000	2700 • Warm White	320	≥80	no	E27	45 x 80

FIREFLY BASIC Series Filament LED Candle

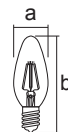

EBC904WW

Light Distribution Curve

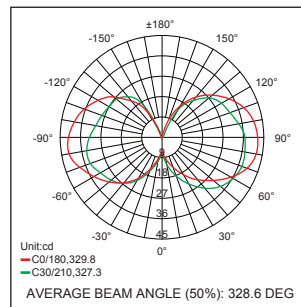

Lux Distance Curve

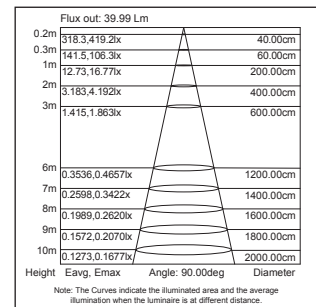

Item Code	Wattage	Lumen Output	Operating Voltage	Life Hours	Color Temperature	Beam Angle	CRI	Dimmable	Lamp Base	Dimensions
	W	Lm	V	Hrs.	K	°		Yes/No		(a x b mm)
EBC904WW	4	450	220-240	15,000	2700 • Warm White	320	≥80	no	E14	35 x 98

Living Room / Dining

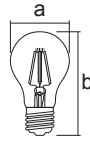

EBI804WW

Light Distribution Curve

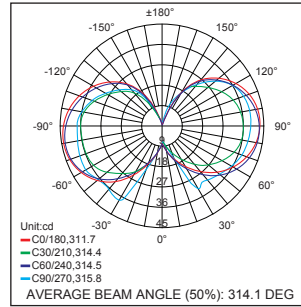

Lux Distance Curve

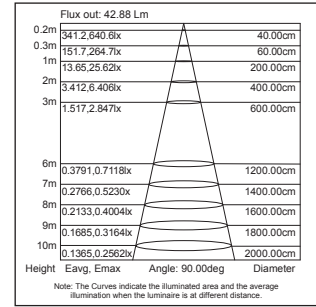

Item Code	Wattage	Lumen Output	Operating Voltage	Life Hours	Color Temperature	Beam Angle	CRI	Dimmable	Lamp Base	Dimensions
	W	Lm	V	Hrs.	K	°		Yes/No		(a x b mm)
EBI804WW	4	320	220-240	15,000	2000 • Warm White	320	≥80	no	E27	60 x 105

FIREFLY BASIC Series Filament LED Vintage Candle

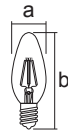

EBC803WW

Light Distribution Curve

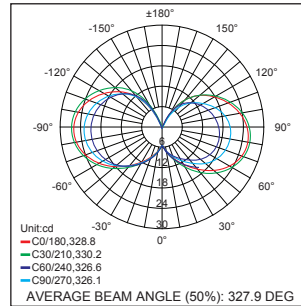

Lux Distance Curve

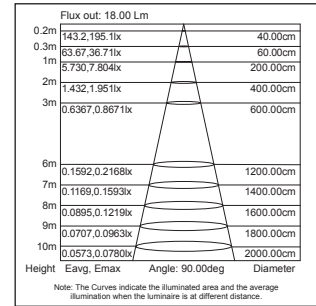

Item Code	Wattage	Lumen Output	Operating Voltage	Life Hours	Color Temperature	Beam Angle	CRI	Dimmable	Lamp Base	Dimensions
	W	Lm	V	Hrs.	K	°		Yes/No		(a x b mm)
EBC803WW	3	200	220-240	15,000	2000 • Warm White	320	≥80	no	E14	35 x 98

FIREFLY BASIC Series Filament LED Vintage Globe

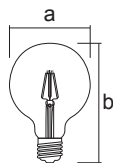

EBG805WW

Light Distribution Curve

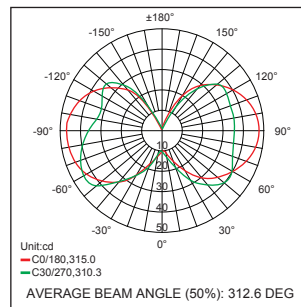

Lux Distance Curve

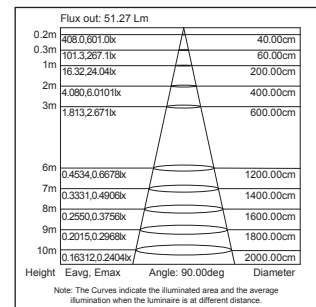

Item Code	Wattage	Lumen Output	Operating Voltage	Life Hours	Color Temperature	Beam Angle	CRI	Dimmable	Lamp Base	Dimensions
	W	Lm	V	Hrs.	K	°		Yes/No		(a x b mm)
EBG805WW	5	470	220-240	15,000	2000 • Warm White	320	≥80	no	E27	95 x 138

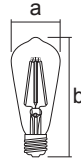
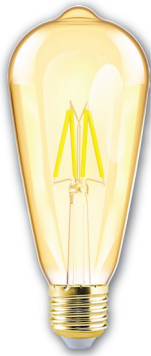

EBST805WW

Light Distribution Curve

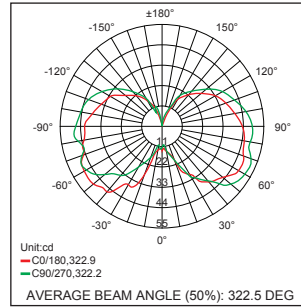

Lux Distance Curve

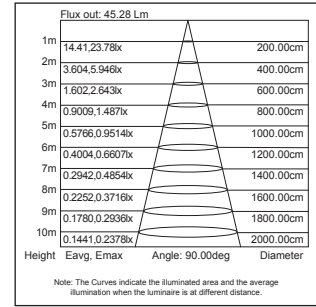

Item Code	Wattage	Lumen Output	Operating Voltage	Life Hours	Color Temperature	Beam Angle	CRI	Dimmable	Lamp Base	Dimensions
	W	Lm	V	Hrs.	K	°		Yes/No		(a x b mm)
EBST805WW	5	470	220-240	15,000	2000 • Warm White	320	≥80	no	E27	64 x 145

FIREFLY BASIC Series Filament LED Full Light

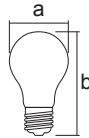

EBI704WW

Light Distribution Curve

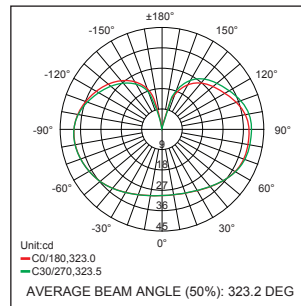

Lux Distance Curve

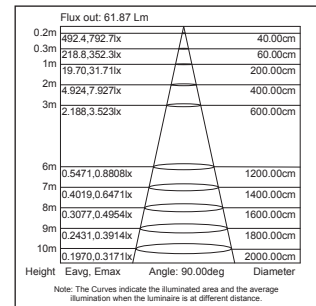

Item Code	Wattage	Lumen Output	Operating Voltage	Life Hours	Color Temperature	Beam Angle	CRI	Dimmable	Lamp Base	Dimensions
	W	Lm	V	Hrs.	K	°		Yes/No		(a x b mm)
EBI704WW	4	470	220-240	15,000	2700 • Warm White	320	≥80	no	E27	60 x 105

Living Room / Dining

BEDROOM



FCL625TC

 **Bluetooth®** SPEAKER
 -COLOR CEILING LAMP

Functional LED Lamps

BRIGHT. LONG-LASTING. INNOVATIVE.

Plug and play your favorite music and set the perfect ambiance.

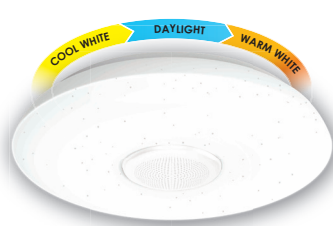

Bluetooth SPEAKER
3-COLOR CEILING LAMP

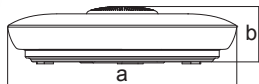

FCL625TC

Light Distribution Curve

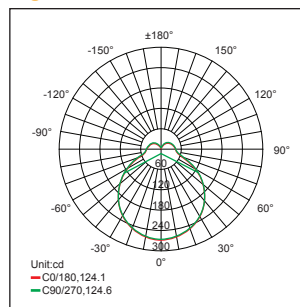

Lux Distance Curve

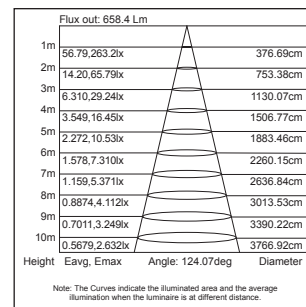

Item Code	Wattage	Lumen Output	Operating Voltage	Life Hours	Color Temperature	Beam Angle	CRI	Dimmable	Dimensions
	W	Lm	V	Hrs.	K	°		Yes/No	(a x b mm)
FCL625TC	20	1350 1350 1200	100-240	25,000	4000 • Cool White 6500 • Daylight 3000 • Warm White	120	≥ 85	no	356 x 86

FIREFLY PRO Series 3-Step Dimming



3 Step Dimming

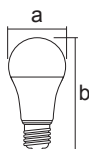

FBF311WW

Light Distribution Curve

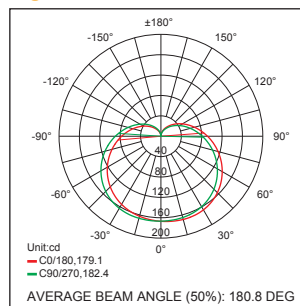

Lux Distance Curve

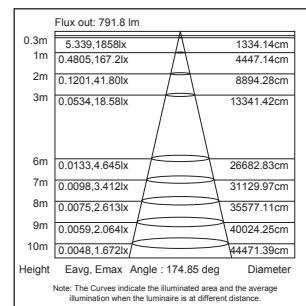

Item Code	Wattage	Lumen Output	Operating Voltage	Life Hours	Color Temperature	Beam Angle	CRI	Dimmable	Lamp Base	Dimensions
	W	Lm	V	Hrs.	K	°		Yes/No		(a x b mm)
FBF309DL	9 4 1	806	100-240	25,000	6500 • Daylight	230	≥ 80	yes*	E27	60 x 110
FBF311WW	11 5 2	1030	100-240	25,000	3000 • Warm White	230	≥ 80	yes*	E27	60 x 110
FBF312WW	12 7 2	880 620 250	220-240	25,000	3000 • Warm White	230	≥ 80	yes*	E27	60 x 123

*To be used with standard switch only. Not to be used with any dimming devices.

Bedroom

FIREFLY PRO Series Bluetooth® Speaker 2-Color Bulb



Bluetooth® SPEAKER
2-COLOR BULB

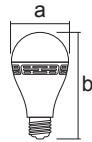

FBF606DC

Light Distribution Curve

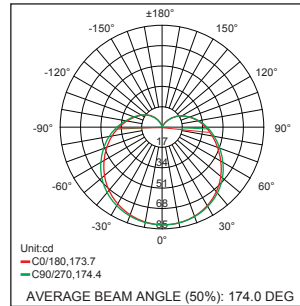

Lux Distance Curve

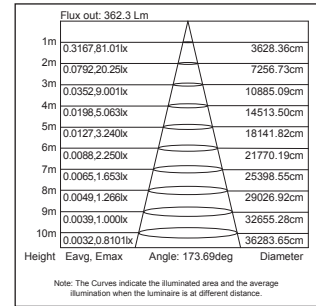

Item Code	Wattage	Lumen Output	Operating Voltage	Life Hours	Color Temperature	Beam Angle	CRI	Dimmable	Lamp Base	Dimensions
	W	Lm	V	Hrs.	K	°		Yes/No		(a x b mm)
FBF606DC	6	470	220-240	25,000	6500 • Daylight 3000 • Warm White	180	≥ 80	no	E27	66 x 125

FIREFLY PRO Series Bluetooth® Speaker LED Lamp



Bluetooth® SPEAKER

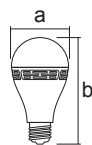

FBF606DL

Light Distribution Curve

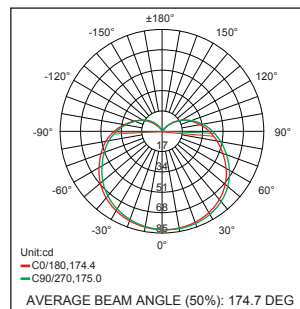

Lux Distance Curve

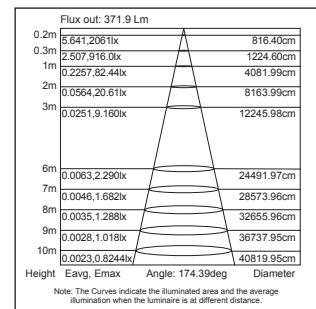

Product Description	Wattage	Lumen Output	Operating Voltage	Life Hours	Color Temperature	Beam Angle	CRI	Dimmable	Lamp Base	Dimensions
Item Code	W	Lm	V	Hrs.	K	°		Yes/No		(a x b mm)
FBF606DL	6	470	100-240	25,000	6500 • Daylight	180	≥ 80	no	E27	66 x 125

FIREFLY PRO Series Dimmable A-Bulb Singles

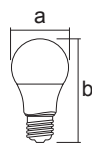

FBI609WW

Light Distribution Curve

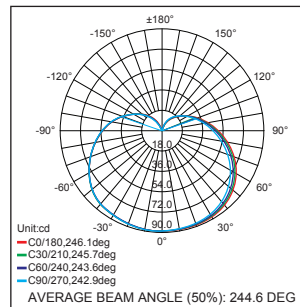

Lux Distance Curve

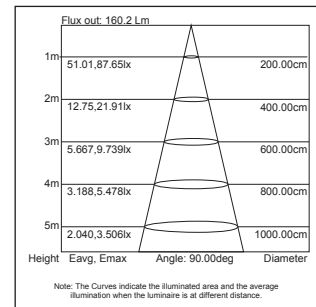

Item Code	Wattage	Lumen Output	Operating Voltage	Life Hours	Color Temperature	Beam Angle	CRI	Dimmable	Lamp Base	Dimensions
	W	Lm	V	Hrs.	K	°		Yes/No		(a x b mm)
FBI609WW	9	800	220-240	25,000	3000 • Warm White	200	≥ 80	yes	E27	60 x 110

ECL124DL

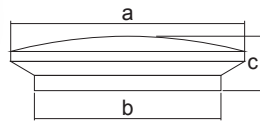

Light Distribution Curve

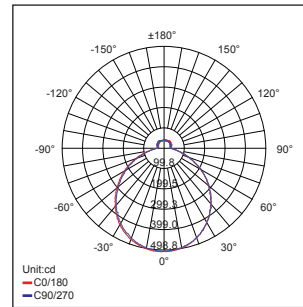

Lux Distance Curve

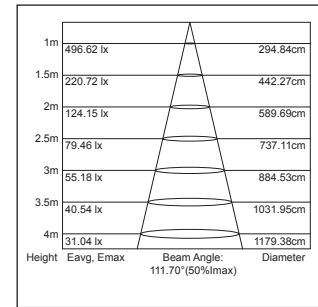

Item Code	Wattage	Lumen Output	Operating Voltage	Life Hours	Color Temperature	Beam Angle	CRI	Dimmable	Dimensions
	W	Lm	V	Hrs.	K	°		Yes/No	(a x b x c mm)
ECL112DL	12	770	165-250	15,000	6500 • Daylight	180	≥ 80	no	265 x 230 x 53
ECL118DL	18	1200	165-250	15,000	6500 • Daylight	180	≥ 80	no	340 x 300 x 55
ECL124DL	24	1400	165-250	15,000	6500 • Daylight	180	≥ 80	no	390 x 350 x 58

FIREFLY BASIC Series LED Classic Ceiling Lamp - Pepper Design

ECL224DL

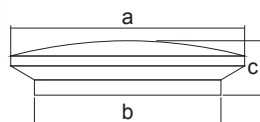
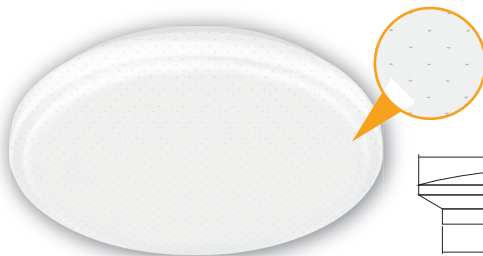

Light Distribution Curve

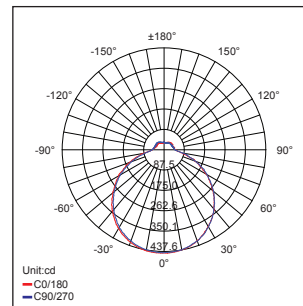

Lux Distance Curve

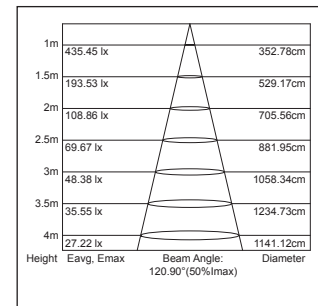

Item Code	Wattage	Lumen Output	Operating Voltage	Life Hours	Color Temperature	Beam Angle	CRI	Dimmable	Dimensions
	W	Lm	V	Hrs.	K	°		Yes/No	(a x b x c mm)
ECL212DL	12	770	165-250	15,000	6500 • Daylight	180	≥ 80	no	265 x 230 x 53
ECL218DL	18	1200	165-250	15,000	6500 • Daylight	180	≥ 80	no	340 x 300 x 55
ECL224DL	24	1400	165-250	15,000	6500 • Daylight	180	≥ 80	no	390 x 350 x 58

Bedroom

ECL324DL

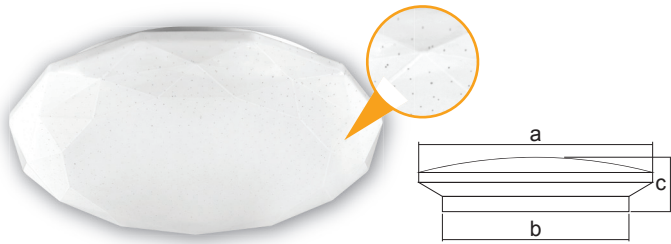

Light Distribution Curve

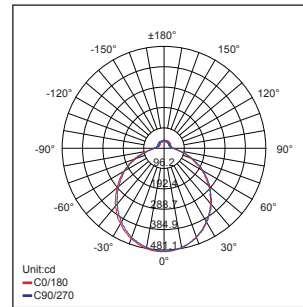

Lux Distance Curve

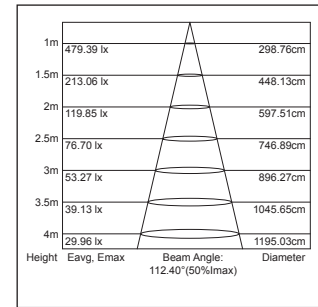

Item Code	Wattage	Lumen Output	Operating Voltage	Life Hours	Color Temperature	Beam Angle	CRI	Dimmable	Dimensions
	W	Lm	V	Hrs.	K	°		Yes/No	(a x b x c mm)
ECL312DL	12	770	165-250	15,000	6500 • Daylight	180	≥ 80	no	265 x 230 x 53
ECL318DL	18	1200	165-250	15,000	6500 • Daylight	180	≥ 80	no	340 x 300 x 55
ECL324DL	24	1400	165-250	15,000	6500 • Daylight	180	≥ 80	no	390 x 350 x 58

FIREFLY BASIC Series LED Circular Tube

ECL820DL

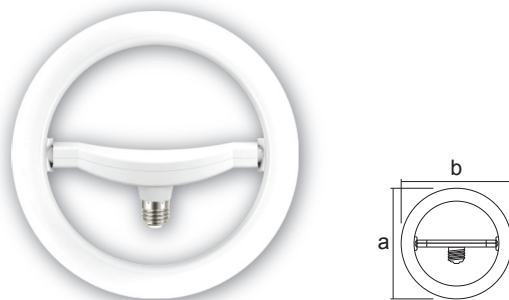

Light Distribution Curve

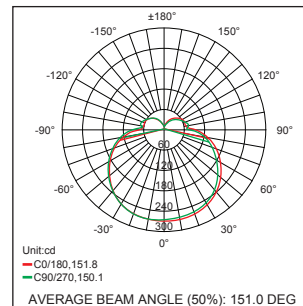

Lux Distance Curve

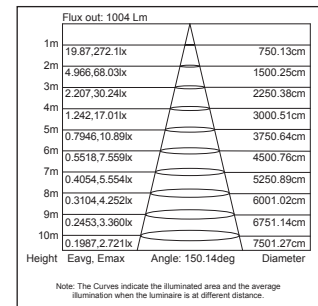

Item Code	Wattage	Lumen Output	Operating Voltage	Life Hours	Color Temperature	Beam Angle	CRI	Dimmable	Lamp Base	Dimensions
	W	Lm	V	Hrs.	K	°		Yes/No		(a x b mm)
ECL820DL	20	1850	200-240	15,000	6500 • Daylight	180	≥ 80	no	E27	260 x 260

EDL1503DL



Light Distribution Curve

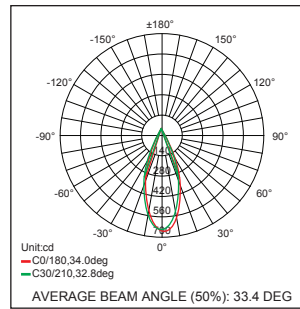

Lux Distance Curve

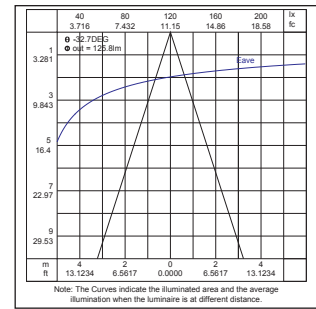

Item Code	Wattage	Lumen Output	Operating Voltage	Life Hours	Color Temperature	Beam Angle	CRI	Dimmable	Dimensions	Cut-out Size
	W	Lm	V	Hrs.	K	°		Yes/No	(a x b mm)	(mm)
EDL1503DL	3	250	100-240	20,000	6500 • Daylight	36	≥ 80	no	56 x 90	68 x 68
EDL1503WW	3	230	100-240	20,000	3000 • Warm White	36	≥ 80	no	56 x 90	68 x 68
EDL1505DL	5	450	100-240	20,000	6500 • Daylight	36	≥ 80	no	56 x 90	68 x 68
EDL1505WW	5	420	100-240	20,000	3000 • Warm White	36	≥ 80	no	56 x 90	68 x 68
EDL1403DL	3	240	100-240	20,000	6500 • Daylight	36	≥ 80	no	56 x 80	68 x 68
EDL1403WW	3	230	100-240	20,000	3000 • Warm White	36	≥ 80	no	56 x 80	68 x 68
EDL1406DL	6	435	100-240	20,000	6500 • Daylight	36	≥ 80	no	56 x 80	68 x 68
EDL1406WW	6	415	100-240	20,000	3000 • Warm White	36	≥ 80	no	56 x 80	68 x 68

FIREFLY BASIC Series LED Recessed Tiltable Downlight

EDL2503DL



Light Distribution Curve

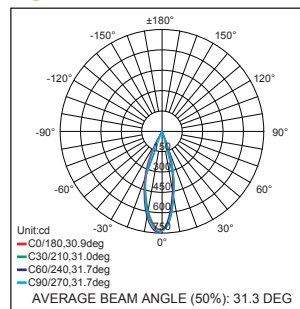

Lux Distance Curve

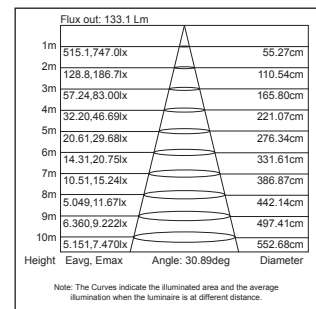

Item Code	Wattage	Lumen Output	Operating Voltage	Life Hours	Color Temperature	Beam Angle	CRI	Dimmable	Dimensions	Cut-out Size
	W	Lm	V	Hrs.	K	°		Yes/No	(a x b mm)	(mm)
EDL2503DL	3	250	100-240	20,000	6500 • Daylight	36	≥ 80	no	56 x Ø 90	Ø 68
EDL2503WW	3	230	100-240	20,000	3000 • Warm White	36	≥ 80	no	56 x Ø 90	Ø 68
EDL2505DL	5	450	100-240	20,000	6500 • Daylight	36	≥ 80	no	56 x Ø 90	Ø 68
EDL2505WW	5	420	100-240	20,000	3000 • Warm White	36	≥ 80	no	56 x Ø 90	Ø 68
EDL2403DL	3	240	100-240	20,000	6500 • Daylight	36	≥ 80	no	56 x Ø 80	Ø 68
EDL2403WW	3	230	100-240	20,000	3000 • Warm White	36	≥ 80	no	56 x Ø 80	Ø 68
EDL2406DL	6	435	100-240	20,000	6500 • Daylight	36	≥ 80	no	56 x Ø 80	Ø 68
EDL2406WW	6	415	100-240	20,000	3000 • Warm White	36	≥ 80	no	56 x Ø 80	Ø 68

Bedroom

KITCHEN



IP44 Rating

FDL2505DL

Functional LED Lamps

BRIGHT. LONG-LASTING. INNOVATIVE.

Keep your workplace safe and bright even if moist, vapor or water is present.

IP44 Rating

FDL2509DL

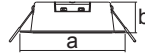

Light Distribution Curve

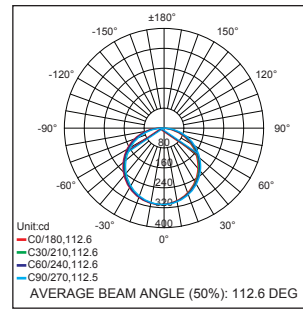

Lux Distance Curve

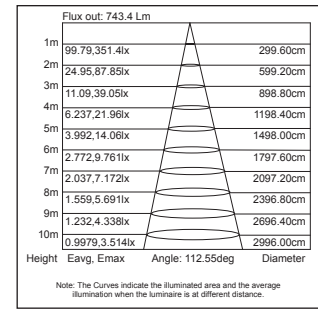

Product Description	Wattage	Lumen Output	Operating Voltage	Life Hours	Color Temperature	Beam Angle	CRI	Dimmable	Dimensions	Cut-out Size
	W	Lm	V	Hrs.	K	°		Yes/No	(a x b x c mm)	(mm)
FDL2505DL	5	480	220-240	30,000	6500 • Daylight	110	≥ 80	no	Ø 120 x 35	Ø 100
FDL2505WW	5	460	220-240	30,000	3000 • Warm White	110	≥ 80	no	Ø 120 x 35	Ø 100
FDL2509DL	9	960	220-240	30,000	6500 • Daylight	110	≥ 80	no	Ø 170 x 35	Ø 150
FDL2509WW	9	910	220-240	30,000	3000 • Warm White	110	≥ 80	no	Ø 170 x 35	Ø 150

ROYU 30A Flush Mount Power Receptacle with Stainless Plate & Box



Item Code	Rated Voltage	Max. Current	Poles
	V	A	
WH941/SL	250V~	30	2P+E

Kitchen

BATHROOM / TOILET



FIREFLY BASIC
Series

Water Resistant led

EBF4109DL

Functional LED Lamps

BRIGHT. LONG-LASTING. INNOVATIVE.

Keep your home safe and bright even if moist, vapor or water is present.

IP54 Rating
AC ONLY

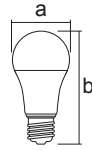

EBF4112DL

Light Distribution Curve

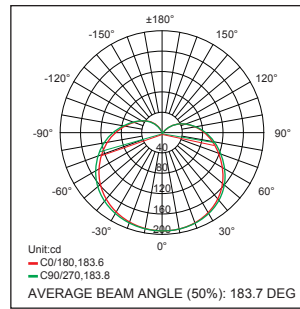

Lux Distance Curve

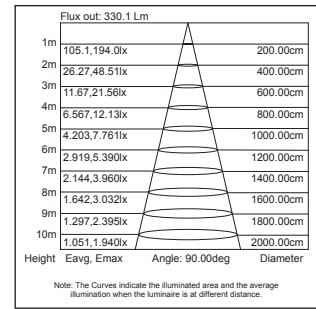

Item Code	Wattage	Lumen Output	Operating Voltage	Life Hours	Color Temperature	Beam Angle	CRI	Dimmable	Lamp Base	Dimensions
	W	Lm	V	Hrs.	K	°		Yes/No		(a x b mm)
EBF4109DL	9	806	100-240	15,000	6500 • Daylight	230	≥ 80	no	E27	60 x 120
EBF4112DL	12	1300	100-240	15,000	6500 • Daylight	230	≥ 80	no	E27	60 x 120

FIREFLY BASIC Series LED MR16

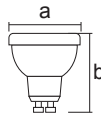

EBH405DLG10

Light Distribution Curve

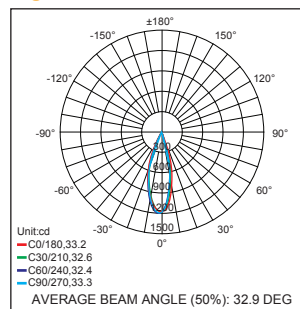

Lux Distance Curve

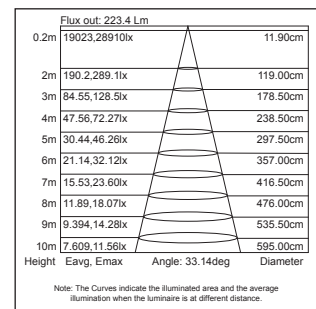

Item Code	Wattage	Lumen Output	Operating Voltage	Life Hours	Color Temperature	Beam Angle	CRI	Dimmable	Lamp Base	Dimensions
	W	Lm	V	Hrs.	K	°		Yes/No		(a x b mm)
EBH403DLG10	3	260	100-240	15,000	6500 • Daylight	36	80	no	GU10	54 x 50
EBH403WWG10	3	250	100-240	15,000	3000 • Warm White	36	80	no	GU10	54 x 50
EBH405DLG10	5	480	100-240	15,000	6500 • Daylight	36	80	no	GU10	54 x 50
EBH405WWG10	5	450	100-240	15,000	3000 • Warm White	36	80	no	GU10	54 x 50

FIREFLY MR16 Downlight Fixtures



IP44 MR16 Fixture
with GU10 Lampholder

- Color : Sandy White Matte
- Material : CNC Aluminum - Powder-coated

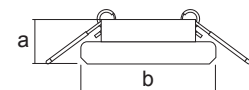

Item Code	Shape	Dimensions	Cut-out Size
		(a x b mm)	(mm)
FD206WH	Round	30 x 85	Ø 60
FD207WH	Square	30 x 85 x 85	Ø 60

Bathroom / Toilet

BATHROOM / TOILET

ELECTRICAL SOLUTIONS



WD932

Duplex GFCI Outlet

HIGH QUALITY. SAFE. VALUE FOR MONEY.

Ensures safety from accidental electric shocks.



Item Code	Mechanical & Electrical Life	Rated Frequency	Rated Current	Rated Voltage	Sensitivity
		Hz	A	V	mA
WD932	6000	50/60	16	250	10-15

BENEFITS

- GFCI has a safety mechanical feature that prevents users from electrocution.
- User-friendly features since it has test buttons, reset button to resume power after fault, and light indicator for GFCI status.

WHEN DOES GFCI TEST SHOULD BE DONE?

- After installation to check whether the wiring is properly installed (will not function/no power output).
- At least once a month/after a power failure
- Leakage protection operation characteristics:
Rated operation (Leakage) currents: 10-15mA
Rated leakage current breaking time: ≤0.1s

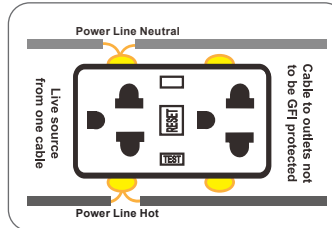

Power Line Terminals must be connected after the circuit breaker. Load Line Terminals are going to the other outlet if applicable.

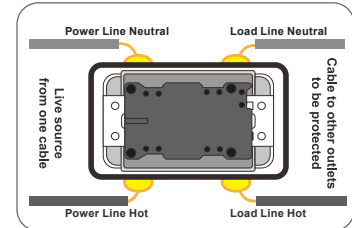

Look for Power Line and Load Line markings at the rear side of the GFCI.

ROYLI® Ceiling Mounted Exhaust Fan

Bathroom / Toilet

Features:

USER-FRIENDLY FEATURES

- Quiet Operation
- Automatic Shutter
- Enhanced Safety & Reliability

EFFICIENT OPERATION

- Low Power Consumption
- High Airflow
- Thermal Fuse

LONGER LIFE USE

- Rust Proof
- Smooth Rotation
- Pure Copper Motor

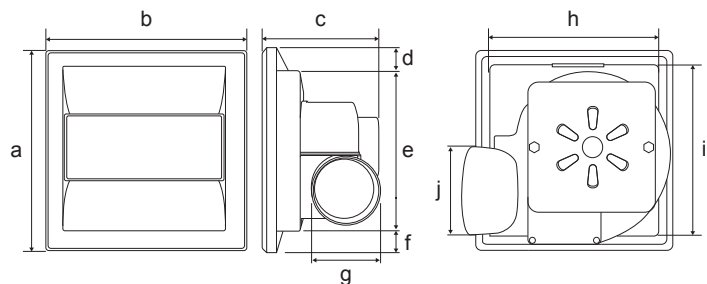

Item Code	Color	Intallation Size	Wattage	Noise	CFM	CHM	CMM	Dimensions (cm)									
								a	b	c	d	e	f	g	h	i	j
REFC03/10	White	9	22	≤ 42	88	150	2.5	27.5	27.5	18.5	2.5	22.5	2.5	10	22.5	22.5	10

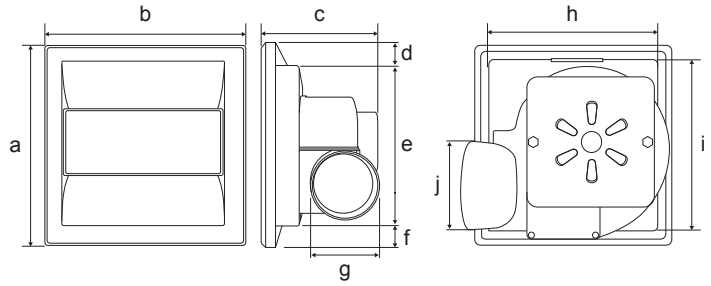

Item Code	Color	Intallation Size	Wattage	Noise	CFM	CHM	CMM	Dimensions (cm)									
								a	b	c	d	e	f	g	h	i	j
REFC05/10	Metal	9	22	≤ 42	88	150	2.5	27.5	27.5	18.5	2.5	22.5	2.5	10	22.5	22.5	10

ROYLI® Ceiling Mounted Exhaust Fan

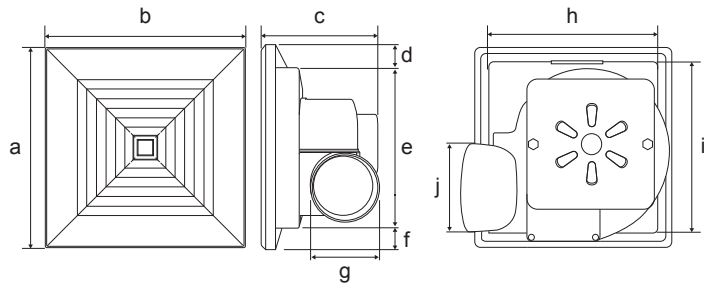

Item Code	Color	Intallation Size	Wattage	Noise	CFM	CHM	CMM	Dimensions (cm)									
								a	b	c	d	e	f	g	h	i	j
REFC07/10	White	8	20	≤ 30	70	120	2.0	25	25	17.5	2.5	20	2.5	10	22.5	22.5	10
REFC07/14	White	12	38	≤ 50	247	420	7.0	36.5	36.5	18.5	3	30.5	3	15	30.5	30.5	15

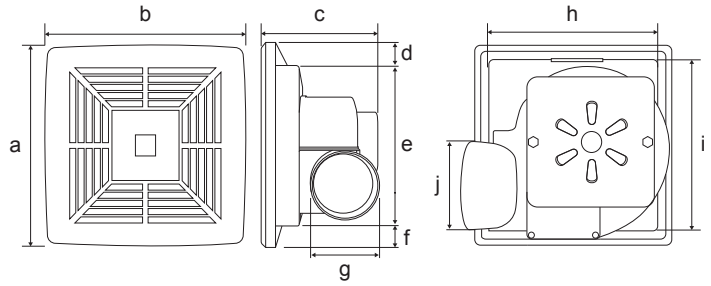

Item Code	Color	Intallation Size	Wattage	Noise	CFM	CHM	CMM	Dimensions (cm)									
								a	b	c	d	e	f	g	h	i	j
REFC09/10	White	8	20	≤ 30	70	120	2.0	25	25	17.5	2.5	20	2.5	10	20	20	10

ROYU® Ceiling Mounted Exhaust Fan

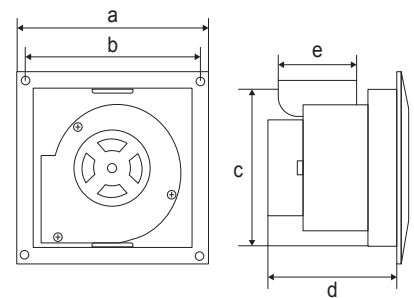

Item Code	Color	Intallation Size	Wattage	Noise	CFM	CHM	CMM	Dimensions (cm)				
								a	b	c	d	e
REFC18/08W	White	8	23	< 46	70.6	222	3.7	24.6	22	20.4	16.6	10
REFC18/10W	White	10	30	< 43	75.6	128	2.1	27	24	22.8	16.8	10

Bathroom / Toilet

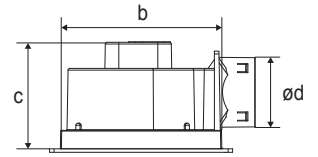
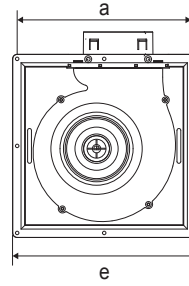

Item Code	Color	Intallation Size	Wattage	Noise	CFM	CHM	CMM	Dimensions (cm)				
								In.	W	dB	a	b
REFC19/08W	White	8	22	< 45	70.6	120	2.0	22	19.8	14.9	10	24.6
REFC19/10W	White	10	25	< 46	77.7	132	2.2	24.5	23.2	15.8	10	27

ROYLI® Ceiling Mounted Exhaust Fan

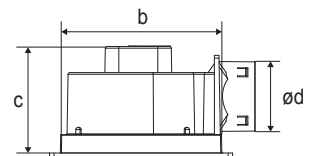
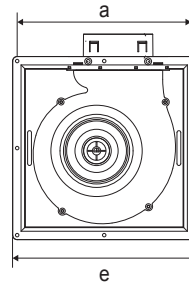

Item Code	Color	Intallation Size	Wattage	Noise	CFM	CHM	CMM	Dimensions (cm)				
								In.	W	dB	a	b
REFC20/08W	White	8	22	< 45	70.6	120	2.0	22	19.8	14.9	10	24.6
REFC20/10W	White	10	25	< 46	77.7	132	2.2	24.5	23.2	15.8	10	27

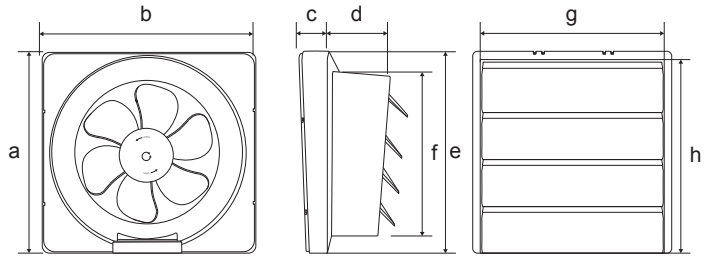

Item Code	Color	Blade Size	Wattage	Noise	CFM	CHM	CMM	Dimensions (cm)							
								In.	W	dB	a	b	c	d	e
REFW01/12	White	8	33	≤ 56	175	300	5.0	30	30	4	9	30	24.5	24.5	24.5
REFW01/14	White	9.5	38	≤ 56	230	390	6.5	34	34	4	9	34	28.5	28.5	28.5

ROYU® Wall Mounted Exhaust Fan

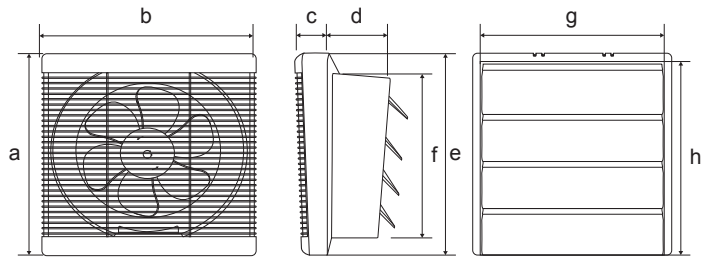

Item Code	Color	Blade Size	Wattage	Noise	CFM	CHM	CMM	Dimensions (cm)							
								In.	W	dB	a	b	c	d	e
REFW03/12	White	8	20	≤ 30	70	120	2.0	30	30	7.5	9	30	24.5	24.5	24.5
REFW03/14	White	9.5	38	≤ 50	247	420	7.0	34	34	7.5	9	34	28.5	28.5	28.5

Bathroom / Toilet

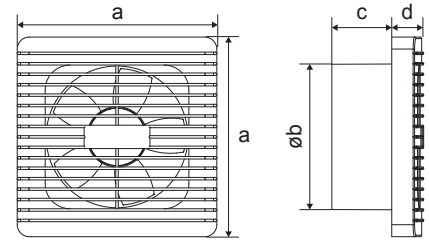

Item Code	Color	Blade Size	Wattage	Noise	CFM	CHM	CMM	Dimensions (cm)			
		In.						W	a	b	c
REFW17/04W	White	4	12	≤ 44	38.1	65	1.1	15	9.8	5	3
REFW17/06W	White	6	13	≤ 44	88.3	150	2.5	20	14.6	6	3.2

ROYLI® Wall Mounted Exhaust Fan

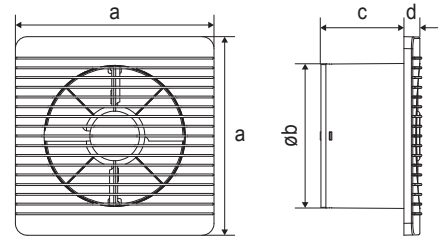

Item Code	Color	Blade Size	Wattage	Noise	CFM	CHM	CMM	Dimensions (cm)			
		In.						W	a	b	c
REFW18/04W	White	4	12	≤ 45	38.8	66	1.1	15	9.9	8.3	1.7
REFW18/06W	White	6	17	≤ 46	81.2	138	2.3	20	14.7	8.4	1.8

HALLWAY



FDLG2x20CW/1

LED Grille Luminaire

BRIGHT. LONG-LASTING. REALISTIC COLORS.

Sets up the mood and warmly welcomes guests with the right amount of brightness and colors.

Lifud LED Drivers

CREE LED CHIPS

FDLG1x20CW/1

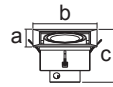

Light Distribution Curve

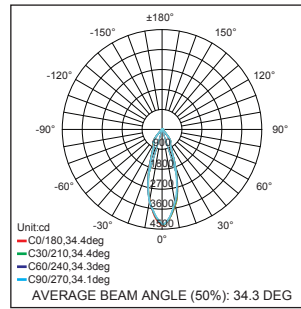

Lux Distance Curve

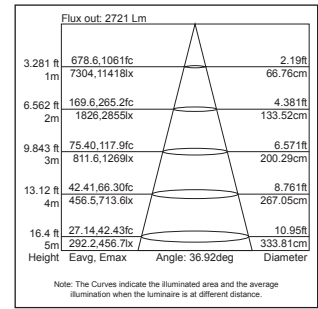

Item Code	Wattage	Lumen Output	Operating Voltage	Life Hours	Color Temperature	Beam Angle	CRI	Dimmable	Dimensions
	W	Lm	V	Hrs.	K	°		Yes/No	(a x b x c mm)
FDLG1x20DL/1	20	1800	220-240	50,000	5000 • Daylight	15 / 38	≥ 90	no	140 x 140 x 125
FDLG1x20WW/1	20	1800	220-240	50,000	3000 • Warm White	15 / 38	≥ 90	no	140 x 140 x 125
FDLG1x20CW/1	20	1800	220-240	50,000	4000 • Cool White	15 / 38	≥ 90	no	140 x 140 x 125

FDLG2x20CW/1

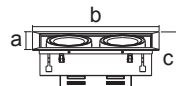

Light Distribution Curve

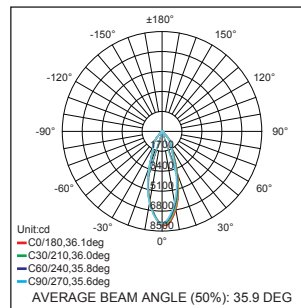

Lux Distance Curve

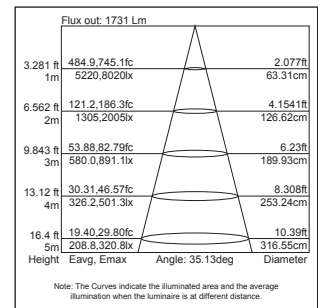

Item Code	Wattage	Lumen Output	Operating Voltage	Life Hours	Color Temperature	Beam Angle	CRI	Dimmable	Dimensions
	W	Lm	V	Hrs.	K	°		Yes/No	(a x b x c mm)
FDLG2x20DL/1	40	3600	220-240	50,000	5000 • Daylight	15 / 38	≥ 90	no	140 x 275 x 125
FDLG2x20WW/1	40	3600	220-240	50,000	3000 • Warm White	15 / 38	≥ 90	no	140 x 275 x 125
FDLG2x20CW/1	40	3600	220-240	50,000	4000 • Cool White	15 / 38	≥ 90	no	140 x 275 x 125

FDLG3x20CW/1



Light Distribution Curve

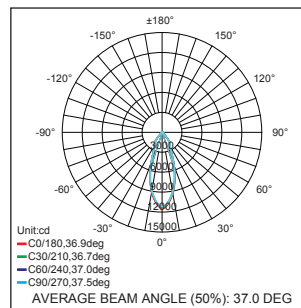

Lux Distance Curve

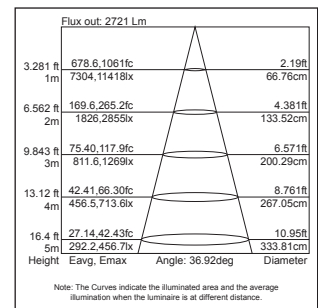

Item Code	Wattage	Lumen Output	Operating Voltage	Life Hours	Color Temperature	Beam Angle	CRI	Dimmable	Dimensions
	W	Lm	V	Hrs.	K	°		Yes/No	(a x b x c mm)
FDLG2x20DL/1	60	5400	220-240	50,000	5000 • Daylight	15 / 38	≥ 90	no	140 x 360 x 125
FDLG2x20WW/1	60	5400	220-240	50,000	3000 • Warm White	15 / 38	≥ 90	no	140 x 360 x 125
FDLG2x20CW/1	60	5400	220-240	50,000	4000 • Cool White	15 / 38	≥ 90	no	140 x 360 x 125



FTL1135WW

Light Distribution Curve

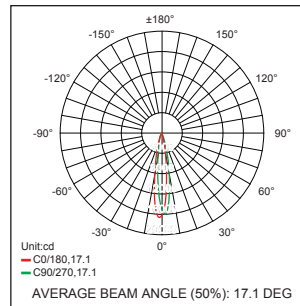

Lux Distance Curve

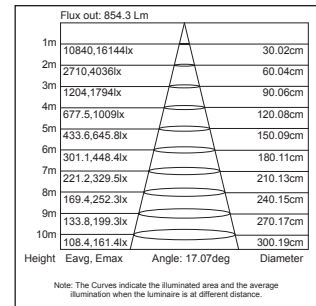

Item Code	Wattage	Lumen Output	Operating Voltage	Life Hours	Color Temperature	Beam Angle	CRI	Dimmable	Dimensions
	W	Lm	V	Hrs.	K	°		Yes/No	(a x b x c mm)
FTL1112WW	12	1100	100-240	30,000	3000 • Warm White	24	90	no	132 x 169mm x Ø 52
FTL1118WW	18	1600	100-240	30,000	3000 • Warm White	24	90	no	132 x 190mm x Ø 60
FTL1125WW	25	2200	100-240	30,000	3000 • Warm White	24	90	no	132 x 190mm x Ø 60
FTL1135WW	35	3000	100-240	30,000	3000 • Warm White	24	90	no	180 x 233mm x Ø 80

Accessory: Track Bar for LED Track Light (3-wire)
FTL1000WH
 Color : White
 Material : Aluminum
 Dimensions : 1000 x 34 x 17 mm



ETL1115WW

Light Distribution Curve

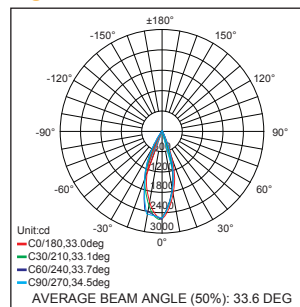

Lux Distance Curve

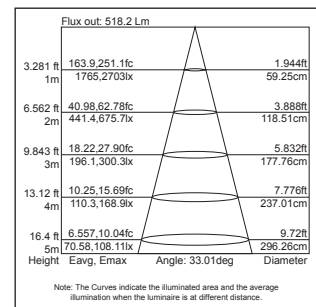

Item Code	Wattage	Lumen Output	Operating Voltage	Life Hours	Color Temperature	Beam Angle	CRI	Dimmable	Dimensions
	W	Lm	V	Hrs.	K	°		Yes/No	(a x b x c mm)
ETL1108WW	8	600	100-240	20,000	3000 • Warm White	38	≥ 80	no	155 x 85 x 60
ETL1115WW	15	1200	100-240	20,000	3000 • Warm White	38	≥ 80	no	180 x 135 x 85

Accessory: Track Bar for LED Track Light (3-wire)
ETL11-TB
 Color : Black
 Material : Aluminum
 Dimensions : 1000 x 34 x 17 mm

Hallway



**Rechargeable Twinhead
Emergency Lamp**

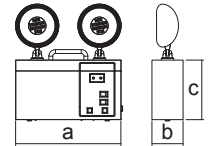
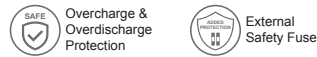

Item Code	FEL201L
Operating Voltage	220-240V AC 50/60Hz
Battery Type	Sealed Lead Acid
Battery Rating	6V 4.5Ah
Lamp	24 pieces 0.06 Watts LED
Charging Time	20 - 24 Hours
Duration Time	32 Hours - 1 Heads 17 Hours - 2 Heads
Response Time	< 0.1 Second
Dimensions (a x b x c mm)	271 x 90 x 300 mm

Dual Optics Emergency Lamp



Item Code	FEL205L
Operating Voltage	220-240V AC 50/60Hz
Battery Type	Lead Acid
Battery Rating	6V 4.5Ah
Lamp	2 pieces 3 Watts Bright LED
Charging Time	20 - 24 Hours
Duration Time	2 Hours
Response Time	< 0.1 Second
Dimensions (a x b x c mm)	337 x 91.5 x 137 mm

Mini Dual Optics

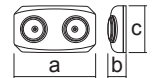

Item Code	FEL207L
Operating Voltage	230V AC
Battery Type	Sealed Lead Acid
Battery Rating	4V 1.6Ah
Lamp	2 pieces 1 Watt Hi-Power LED
Charging Time	20 - 24 Hours
Duration Time	2 Hours
Dimensions (a x b x c mm)	220 x 45 x 126 mm

Dual Optics Emergency Light



Item Code	FEL208L
Operating Voltage	220-240V AC 50/60Hz
Battery Type	Lead Acid Battery
Battery Rating	4V 2Ah
Lamp	16 pieces SMD LED
Charging Time	24 Hours
Duration Time	2 Hours
Dimensions (a x b x c mm)	270 x 60 x 130 mm

BFP Compliant:

PASS under Fire Code of The Philippines SECTION 10.2.5.12 44 (Standard EXIT dimension 19mm X 150mm actual 19mm X 153mm)

PASS under Fire Code of The Philippines SECTION 10.2.5.11 (Minimum duration 1 hour 30 mins)

PASS under IEC 60695-2-11 section 30.2.3. for unattended appliances glow wire test 850 degrees celcius. All plastic parts.

**Single Face 4 LED Exit Sign
Acrylic Type**

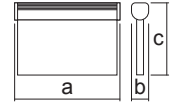
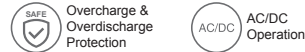

Item Code	FEL221/1	FEL222/1	FEL223/1	FEL224/1	FEL225/1	FEL226/1
Operating Voltage	220-240V AC 50/60Hz					
Battery Type	Rechargeable Ni-CD Battery					
Battery Rating	1.2V 1000mAh					
Lamp	4 pieces 1500mcd 110° LED					
Charging Time	20 - 24 Hours					
Letter Color	• Green					
Duration Time	≥ 90 Minutes (Min.)					
Dimensions (a x b x c mm)	355 x 25 x 250 mm					

Double-Faced Exit Light

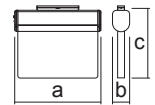

Item Code	FEL227	FEL229
Operating Voltage	220-240V AC 50/60Hz	
Battery Type	Ni-CD Battery	
Battery Rating	3 x 1.2V 350mAh (3.6V)	
Lamp	8 pieces SMD LED	
Charging Time	24 Hours	
Letter Color	• Green	
Duration Time	≥ 90 minutes.	
Dimensions (a x b x c mm)	310 x 50 x 245 mm	

Double-Faced Exit Light

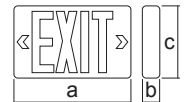

Item Code	FEL228
Operating Voltage	220-240V AC 50/60Hz
Battery Type	Ni-CD Battery
Battery Rating	3.6V 600mAh
Lamp	6 pieces Straw Hat LED
Charging Time	24 Hours
Letter Color	• Green
Duration Time	≥ 90 minutes.
Dimensions (a x b x c mm)	310 x 50 x 245 mm

Hallway

STAIRS



||| **MOTION SENSOR**

FBF210DL

Functional LED Lamps

BRIGHT. LONG-LASTING. INNOVATIVE.

Conveniently and safely enter or exit the room without touching the switch.

MOTION SENSOR

Uses Infrared sensor

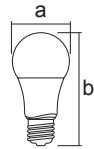

FB210DL

Light Distribution Curve

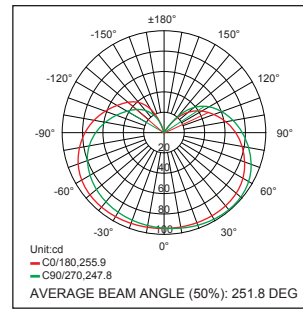

Lux Distance Curve

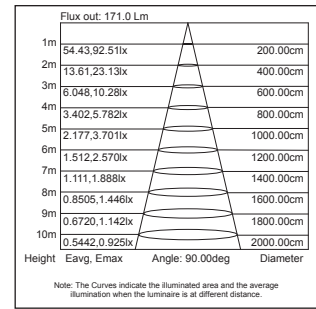

Item Code	Wattage	Lumen Output	Operating Voltage	Life Hours	Color Temperature	Beam Angle	CRI	Dimmable	Lamp Base	Dimensions
	W	Lm	V	Hrs.	K	°		Yes/No		(a x b mm)
FB210DL	10	800	100-240	25,000	6500 • Daylight	240	≥ 80	no	E27	60 x 120
FB210WW	10	800	100-240	25,000	3000 • Warm White	240	≥ 80	no	E27	60 x 120

MOTION SENSOR

Uses PIR sensor

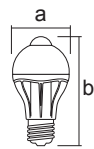

FB206DL

Light Distribution Curve

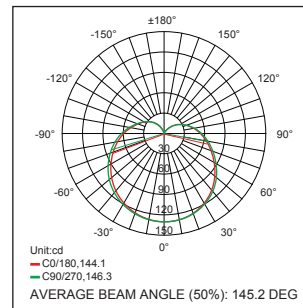

Lux Distance Curve

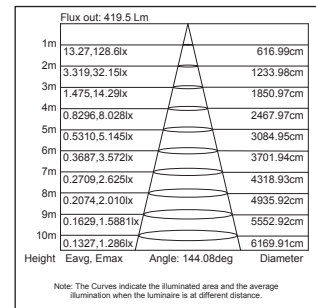

Item Code	Wattage	Lumen Output	Operating Voltage	Life Hours	Color Temperature	Beam Angle	CRI	Dimmable	Lamp Base	Dimensions
	W	Lm	V	Hrs.	K	°		Yes/No		(a x b mm)
FB206DL	6	610	220-240	25,000	6500 • Daylight	200	≥ 80	no	E27	60 x 120
FB206WW	6	600	220-240	25,000	3000 • Warm White	200	≥ 80	no	E27	60 x 120

Stairs

YARD

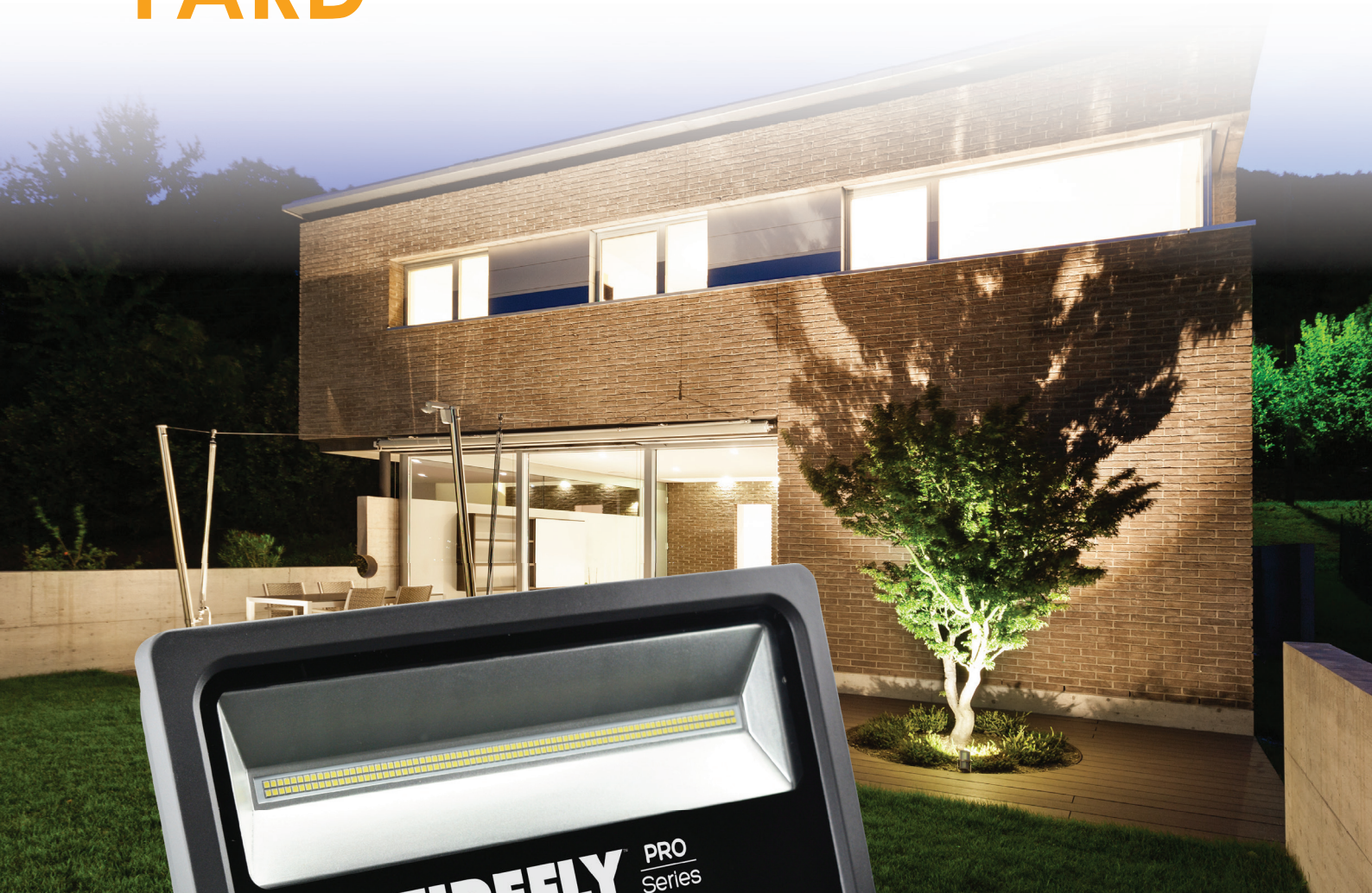

FFL1200DL/G

LED Floodlight

BRIGHT. LONG-LASTING. HEAVY-DUTY.

Worry less on operational costs with lower consumed energy but with brighter lighting output.

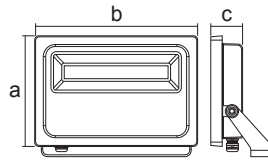

FFL1100DL/G

Light Distribution Curve

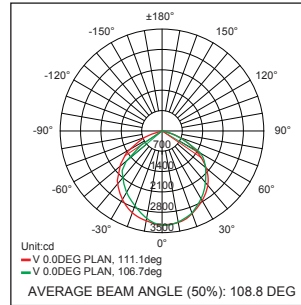

Lux Distance Curve

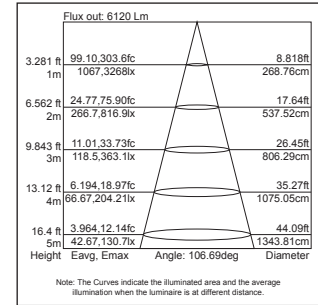

Item Code	Wattage	Lumen Output	Operating Voltage	Life Hours	Color Temperature	Beam Angle	CRI	Dimmable	IP Rating	Dimensions
	W	Lm	V	Hrs.	K	°		Yes/No		(a x b x c mm)
FFL1010DL/G	10	950	90-265	30,000	6000 • Daylight	110	≥ 80	no	IP65	95 x 140 x 37
FFL1010WW/G	10	850	90-265	30,000	3000 • Warm White	110	≥ 80	no	IP65	95 x 140 x 37
FFL1020DL/G	20	1900	90-265	30,000	6000 • Daylight	110	≥ 80	no	IP65	95 x 140 x 37
FFL1020WW/G	20	1700	90-265	30,000	3000 • Warm White	110	≥ 80	no	IP65	95 x 140 x 37
FFL1030DL/G	30	2850	90-265	30,000	6000 • Daylight	110	≥ 80	no	IP65	165 x 243 x 48
FFL1030WW/G	30	2550	90-265	30,000	3000 • Warm White	110	≥ 80	no	IP65	165 x 243 x 48
FFL1050DL/G	50	4750	90-265	30,000	6000 • Daylight	110	≥ 80	no	IP65	165 x 243 x 48
FFL1050WW/G	50	4250	90-265	30,000	3000 • Warm White	110	≥ 80	no	IP65	165 x 243 x 48
FFL1070DL/G	70	6650	90-265	30,000	6000 • Daylight	110	≥ 80	no	IP65	195 x 286 x 55
FFL1070WW/G	70	5950	90-265	30,000	3000 • Warm White	110	≥ 80	no	IP65	195 x 286 x 55
FFL1100DL/G	100	9500	90-265	30,000	6000 • Daylight	110	≥ 80	no	IP65	195 x 286 x 55
FFL1150DL/G	150	14250	90-265	30,000	6000 • Daylight	110	≥ 80	no	IP65	330 x 420 x 70
FFL1200DL/G	200	19000	90-265	30,000	6000 • Daylight	110	≥ 80	no	IP65	330 x 420 x 70

FIREFLY PRO Series LED Mini Streetlight

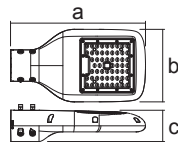

Arm Hole Dimensions



Compatible with Firefly Lamp Post.

FSL1050DL

Light Distribution Curve

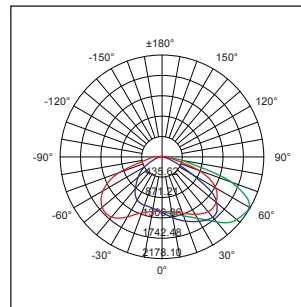

Lux Distance Curve

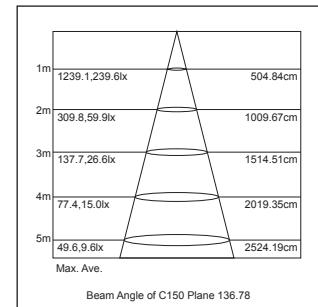

Item Code	Wattage	Lumen Output	Operating Voltage	Life Hours	Color Temperature	Beam Angle	CRI	Dimmable	IP Rating	Dimensions
	W	Lm	V	Hrs.	K	°		Yes/No		(a x b x c mm)
FSL1030DL	30	3600	100-277	50,000	6500 • Daylight	150x95°	≥ 80	no	IP65	335 x 180 x 78
FSL1050DL	50	5000	100-277	50,000	6500 • Daylight	150x95°	≥ 80	no	IP65	335 x 180 x 78



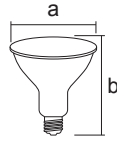

FBP914Y

Light Distribution Curve

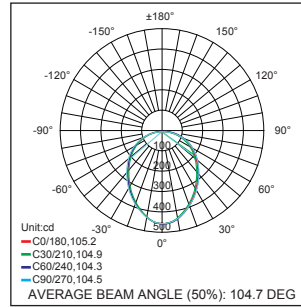

Lux Distance Curve

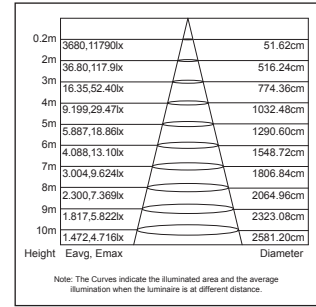

Item Code	Wattage	Operating Voltage	Life Hours	Color Temperature	Beam Angle	CRI	Dimmable	Lamp Base	IP Rating	Dimensions
	W	V	Hrs.	K	°		Yes/No			(a x b x c mm)
FBP914Y	14	100-240	25,000	• Yellow	60	≥ 80	no	E27	IP65	121 X 136
FBP914B	14	100-240	25,000	• Blue	60	≥ 80	no	E27	IP65	121 X 136
FBP914R	14	100-240	25,000	• Red	60	≥ 80	no	E27	IP65	121 X 136
FBP914G	14	100-240	25,000	• Green	60	≥ 80	no	E27	IP65	121 X 136

FIREFLY BASIC Series LED Pad Floodlight

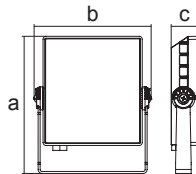

EDL2503DL

Light Distribution Curve

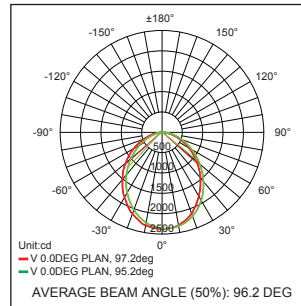

Lux Distance Curve

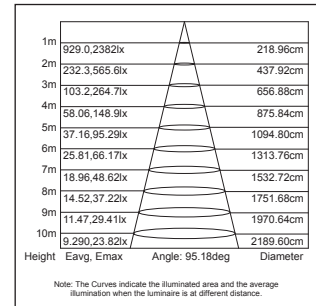

Item Code	Wattage	Lumen Output	Operating Voltage	Life Hours	Color Temperature	Beam Angle	CRI	Dimmable	IP Rating	Dimensions
	W	Lm	V	Hrs.	K	°		Yes/No		(a x b x c mm)
EFL3110DL	10	850	100-240	25,000	6000 • Daylight	110	≥ 80	no	IP65	137 x 117 x 27
EFL3120DL	20	1700	100-240	25,000	6000 • Daylight	110	≥ 80	no	IP65	158 x 134 x 28
EFL3130DL	30	2550	100-240	25,000	6000 • Daylight	110	≥ 80	no	IP65	220 x 167 x 35
EFL3150DL	50	4250	100-240	25,000	6000 • Daylight	110	≥ 80	no	IP65	300 x 222 x 37
EFL3170DL	70	5950	100-240	25,000	6000 • Daylight	110	≥ 80	no	IP65	301 x 222 x 38

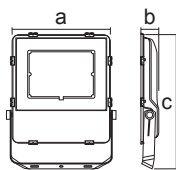

EFL04150DL

Light Distribution Curve

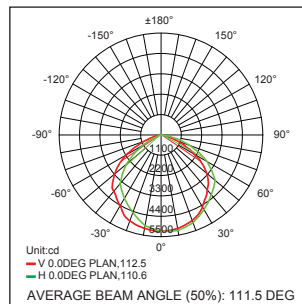

Lux Distance Curve

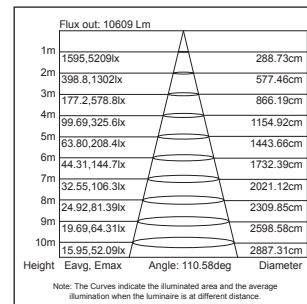

Item Code	Wattage	Lumen Output	Operating Voltage	Life Hours	Color Temperature	Beam Angle	CRI	Dimmable	IP Rating	Dimensions
	W	Lm	V	Hrs.	K	°		Yes/No		(a x b x c mm)
EFL04100DL	100	9000	100-240	30,000	5700 • Daylight	110	≥ 80	no	IP65	296 x 60 x 403
EFL04150DL	150	16500	100-240	30,000	5700 • Daylight	110	≥ 80	no	IP65	331 x 60 x 453

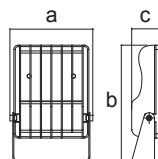

EFL5050DL

Light Distribution Curve

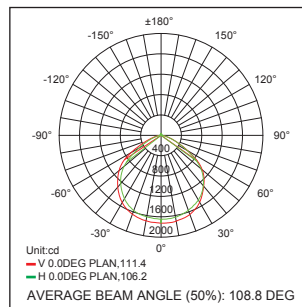

Lux Distance Curve

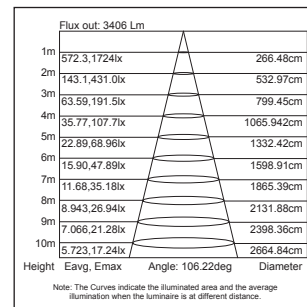

Item Code	Wattage	Lumen Output	Operating Voltage	Life Hours	Color Temperature	Beam Angle	CRI	Dimmable	IP Rating	Dimensions
	W	Lm	V	Hrs.	K	°		Yes/No		(a x b x c mm)
EFL5010DL	10	850	100-240	20,000	5700 • Daylight	110	≥ 80	no	IP65	155 x 105 x 38
EFL5020DL	20	1900	100-240	20,000	5700 • Daylight	110	≥ 80	no	IP65	165 x 115 x 38
EFL5030DL	30	2850	100-240	20,000	5700 • Daylight	110	≥ 80	no	IP65	190 x 140 x 38
EFL5050DL	50	4750	100-240	20,000	5700 • Daylight	110	≥ 80	no	IP65	210 x 170 x 38

Yard



Aluminum Alloy Body

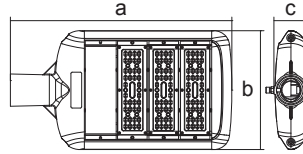

Arm Hole Dimensions

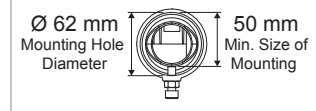

Compatible with Firefly Lamp Post.

ESL4090DL

Light Distribution Curve

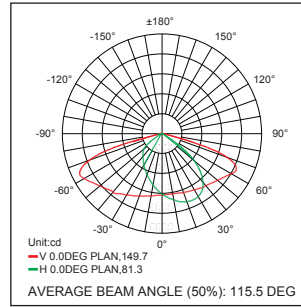

Lux Distance Curve

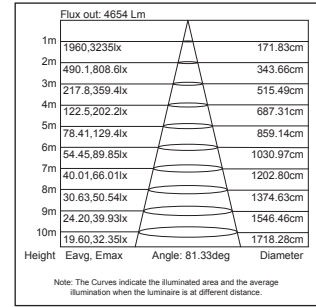

Item Code	Wattage	Lumen Output	Operating Voltage	Life Hours	Color Temperature	Beam Angle	CRI	Dimmable	IP Rating	Dimensions
	W	Lm	V	Hrs.	K	°		Yes/No		(a x b x c mm)
ESL4030DL	30	3000	90-305	30,000	5700 • Daylight	145	70	no	IP65	354 x 265 x 74
ESL4060DL	60	6000	90-305	30,000	5700 • Daylight	145	70	no	IP65	424 x 265 x 74
ESL4090DL	90	9000	90-305	30,000	5700 • Daylight	145	70	no	IP65	494 x 265 x 74
ESL4120DL	120	12000	90-305	30,000	5700 • Daylight	145	70	no	IP65	494 x 265 x 74

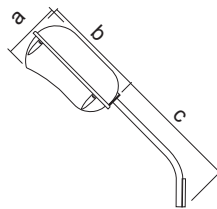

ELSR112DL

Light Distribution Curve

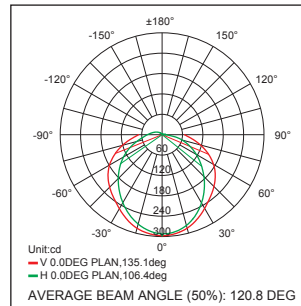

Lux Distance Curve

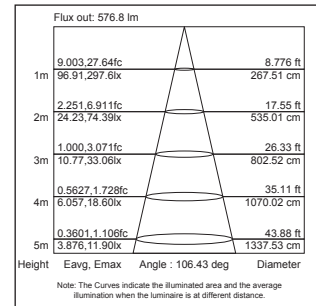

Item Code	Wattage	Lumen Output	Operating Voltage	Life Hours	Color Temperature	Beam Angle	CRI	Dimmable	IP Rating	Dimensions
	W	Lm	V	Hrs.	K	°		Yes/No		(a x b x c mm)
ELSR112DL	12	960	90-265	30,000	6000 • Daylight	120	70	no	IP65	105 x 200 x 285

EBP910DL

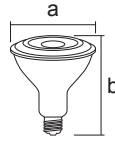

Light Distribution Curve

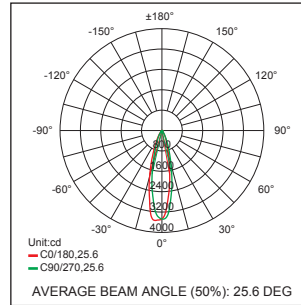

Lux Distance Curve

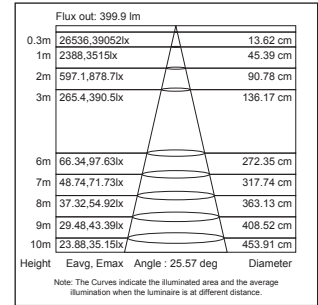

Item Code	Wattage	Lumen Output	Operating Voltage	Life Hours	Color Temperature	Beam Angle	CRI	Dimmable	Lamp Base	IP Rating	Dimensions
	W	Lm	V	Hrs.	K	°		Yes/No			(a x b mm)
EBP910DL	10	1050	100-240	25,000	6500 • Daylight	25	80	no	E27	IP65	121 X 136
EBP910WW	10	1000	100-240	25,000	3000 • Warm White	25	80	no	E27	IP65	121 X 136
EBP914DL	14	1460	100-240	25,000	6500 • Daylight	25	80	no	E27	IP65	121 X 136
EBP914WW	14	1400	100-240	25,000	3000 • Warm White	25	80	no	E27	IP65	121 X 136

FIREFLY Outdoor In-ground



Garden Lamp-outdoor Halogen Dichroic Lamp
Fixture Only

- Material : Aluminum Die-cast
- Diffuser : Toughened Glass

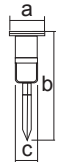

Item Code	Lamp Base	IP Rating	Dimensions
			(a x b x c mm)
FGLH111	GU5.3	IP65	98 x 320 x 68



Garden Lamp-outdoor Halogen Dichroic Lamp
Fixture Only

- Material : Aluminum Die-cast
- Diffuser : Toughened Glass

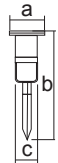

Item Code	Lamp Base	IP Rating	Dimensions
			(a x b x c mm)
FGLH121	GU5.3	IP65	98 x 320 x 68



Outdoor In-ground
Fixture Only

- Material : Aluminum Die-cast
- Diffuser : Toughened Glass

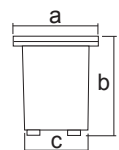

Item Code	Lamp Base	IP Rating	Dimensions
			(a x b x c mm)
FOIG312	E27	IP65	170 x 200 x 130

Yard



Weatherproof E27 Lamp Holder
In-ground for PAR30 & PAR38 Lamps - Fixture Only

- Water Resistant
- Flame Retardant
- Color Fade Resistant
- Easy to Install
- Excellent Electrical Conductivity

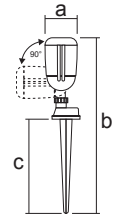

Item Code	Wattage	Voltage	IP Rating	Dimensions
	W	V		(a x b x c mm)
FELH201	150	250	IP65	Ø 60.84 x 379 x 201.6



Weatherproof Twin E27 Lamp Holder
In-ground for PAR30 & PAR38 Lamps - Fixture Only

- Water Resistant
- Flame Retardant
- Color Fade Resistant
- Easy to Install
- Excellent Electrical Conductivity

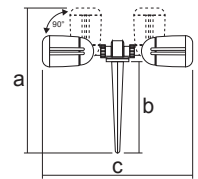

Item Code	Wattage	Voltage	IP Rating	Dimensions
	W	V		(a x b x c mm)
FELH202	2 x 150	250	IP65	329.17 x 339.04 x 201.6



Weatherproof E27 Lamp Holder
Wall / Eaves Mount for PAR30 & PAR38 Lamps - Fixture Only

- Water Resistant
- Flame Retardant
- Color Fade Resistant
- Easy to Install
- Excellent Electrical Conductivity

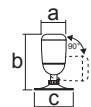

Item Code	Wattage	Voltage	IP Rating	Dimensions
	W	V		(a x b x c mm)
FELH211	150	250	IP65	Ø 60.64 x 171.2 x Ø 115

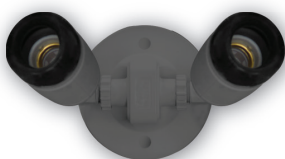

Weatherproof Twin E27 Lamp Holder
Wall / Eaves Mount for PAR30 & PAR38 Lamps - Fixture Only

- Water Resistant
- Flame Retardant
- Color Fade Resistant
- Easy to Install
- Excellent Electrical Conductivity

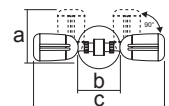

Item Code	Wattage	Voltage	IP Rating	Dimensions
	W	V		(a x b x c mm)
FELH212	2 x 150	250	IP65	137.7 x Ø 99.5 x 339.54



Prismatic Clear Diffuser

Fixture Only

- Material : PMMA (Polymethyl Methacrylate)
ABS (Acrylonitrile-Butadiene-Styrene)

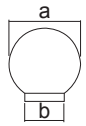

Item Code	Installation	IP Rating	Dimensions
			(a x b x c mm)
FOGL511/8	Post	IP44	203 x 100
FOGL511/10	Post	IP44	254 x 126



Prismatic Smoke Diffuser

Fixture Only

- Material : PMMA (Polymethyl Methacrylate)
ABS (Acrylonitrile-Butadiene-Styrene)

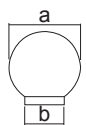

Item Code	Installation	IP Rating	Dimensions
			(a x b x c mm)
FOGL512/8	Post	IP44	203 x 100
FOGL512/10	Post	IP44	254 x 126



Plain Clear Diffuser

Fixture Only

- Material : PMMA (Polymethyl Methacrylate)
ABS (Acrylonitrile-Butadiene-Styrene)

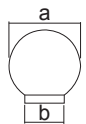

Item Code	Installation	IP Rating	Dimensions
			(a x b x c mm)
FOGL531/8	Post	IP44	203 x 100
FOGL531/10	Post	IP44	254 x 126



Plain White Opal Diffuser

Fixture Only

- Material : PMMA (Polymethyl Methacrylate)
ABS (Acrylonitrile-Butadiene-Styrene)

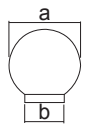

Item Code	Installation	IP Rating	Dimensions
			(a x b x c mm)
FOGL533/8	Post	IP44	203 x 100
FOGL533/10	Post	IP44	254 x 126

Yard



Outdoor Bollard

Fixture Only

- Material : Aluminum Die-cast
- Diffuser : Glass

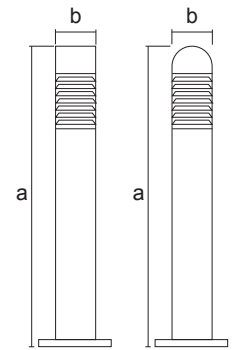

Item Code	Lamp Base	IP Rating	Dimensions
			(a x b x c mm)
FOBO911	E27	IP65	900 x 135
FOBO912	E27	IP65	900 x 135

FIREFLY Wall Lamps



Outdoor Wall Lamp

Fixture Only

- Material : Aluminum Die-cast
- Diffuser : Toughened Glass

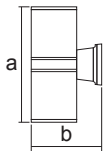

Item Code	Installation	IP Rating	Dimensions
			(a x b x c mm)
FOWL711	2 x E27	IP65	260 x 155

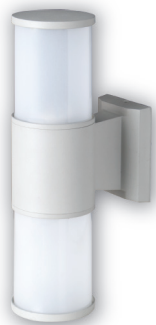

Outdoor Wall Lamp

Fixture Only

- Material : Aluminum Die-cast
- Diffuser : Toughened Glass

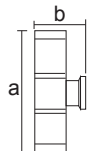

Item Code	Installation	IP Rating	Dimensions
			(a x b x c mm)
FOWL713	2 x E27	IP65	315 x 155
FOWL714	2 x E27	IP65	315 x 167



Projection Light

Fixture Only

- Material : Aluminum Die-cast
- Diffuser : Toughened Glass

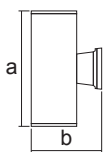

Item Code	Installation	IP Rating	Dimensions
			(a x b x c mm)
FOWL721	2 x E27	IP65	260 x 150

*Customized lamp post designs are accepted.
Process and production lead times to be discussed with client.*

- Hot dip galvanized Lamp Post and Arm
- Epoxy silver paint finish
- Anchor bolts with nuts and washer
- With arm attachment accessories
- One-piece round tapered shaft
- Steel base plate
- Q235 Steel
- Can withstand up to 120kph wind speed
- Maximum Static Load of 40kgs.
(Arm/Lamp/Accessories Attachment)
- 3mm thickness

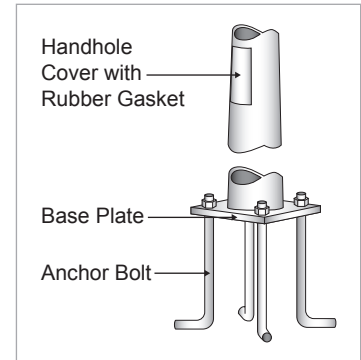

Single Arm
For Lamp Post

Item Code	Description	General Dimensions
FRL3-SA5X5.4	Single Arm for All Lamp Posts	5 ft. x 5.4 ft.

Double Arm
For Lamp Post

Item Code	Description	General Dimensions
FRL/DA5X10	Double Arm for All Lamp Posts	5 ft. x 10 ft.

Lamp Post

Item Code	Description	General Dimensions
FRL3-P15-4	Post for Lamp Post 15'	10 ft. x 105 mm Ø
FRL3-P20-5	Post for Lamp Post 20'	15 ft.x 125 mm Ø
FRL4-P25-5	Post for Lamp Post 25'	20 ft. x 150 mm Ø
FRL4-P30-6	Post for Lamp Post 30'	25 ft. x 175 mm Ø

Anchor Bolt

Item Code	Description	General Dimensions
FRLA-M18-100X500	Anchor Bolt for Lamp Post 15'	M18 x 500 mm x 100 mm
FRLA-M18-100X600	Anchor Bolt for Lamp Post 20'	M18 x 600 mm x 100 mm
FRLA-M20-100X600	Anchor Bolt for Lamp Post 25'	M20 x 600 mm x 100 mm
FRLA-M20-100X700	Anchor Bolt for Lamp Post 30'	M20 x 700 mm x 100 mm

Note: No powder coating included

Yard

Single Arm

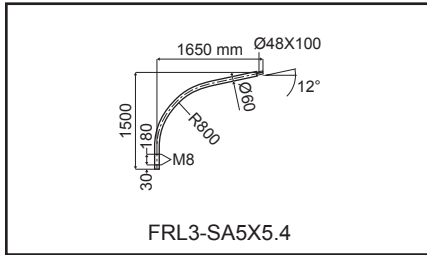

Single Arm

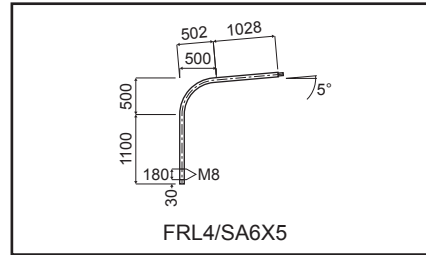

Double Arm

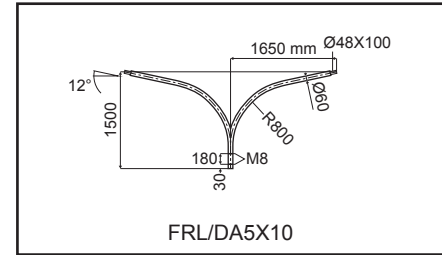

Lamp Post

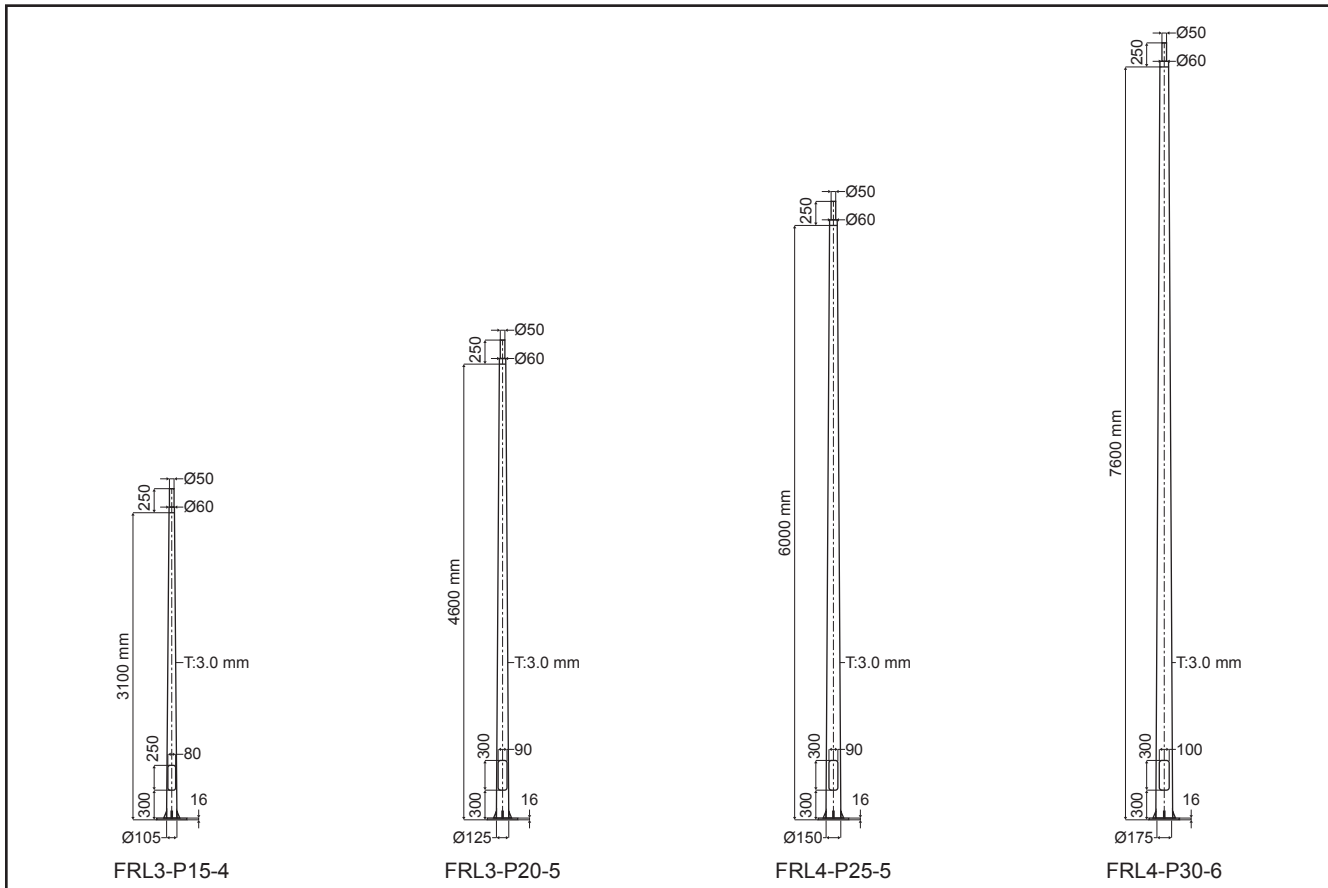

Anchor Bolt

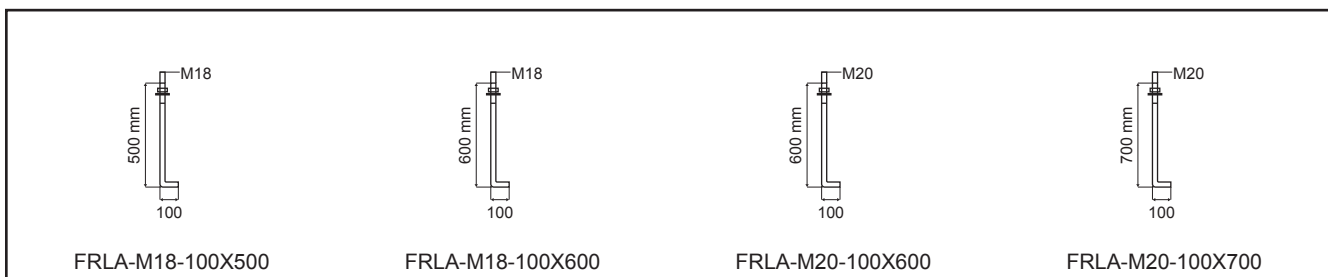

Base Plate

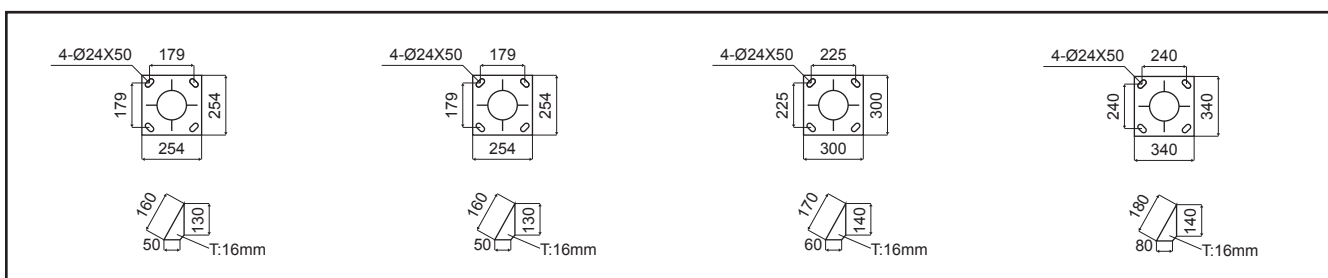

PARKING



FCL2030DL

LED Slim Canopy

HIGH QUALITY. VALUE FOR MONEY. **SAFE.**

Ensures protection from water, dust and corrosion, helping extend an LED lighting's usable life. Guarantees lower operational costs but with brighter lighting output.



FCL2030DL

Light Distribution Curve

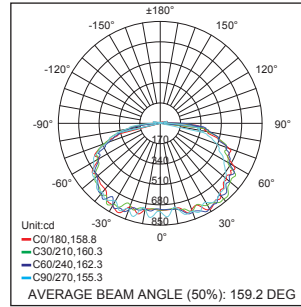

Lux Distance Curve

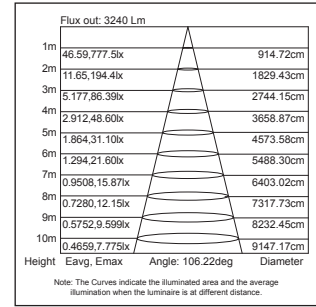

Item Code	Wattage	Lumen Output	Operating Voltage	Life Hours	Color Temperature	Beam Angle	CRI	Dimmable	IP Rating	Dimensions
	W	Lm	V	Hrs.	K	°		Yes/No		(a x b x c mm)
FCL2030DL	30	3600	100-277	50,000	5000 • Daylight	155	70	no	IP65	81.2 x 244 x 244

FIREFLY PRO Series LED Wall Pack

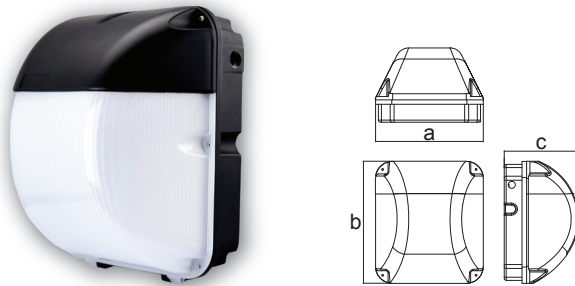

FWCL2020DL

Light Distribution Curve

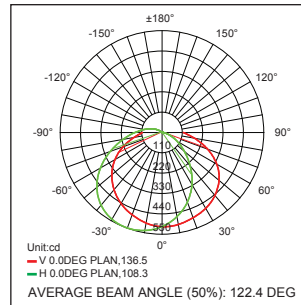

Lux Distance Curve

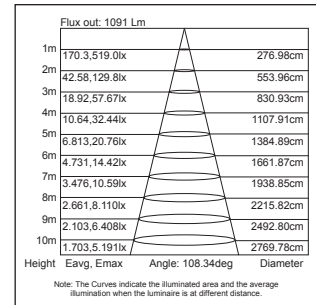

Item Code	Wattage	Lumen Output	Operating Voltage	Life Hours	Color Temperature	Beam Angle	CRI	Dimmable	IP Rating	Dimensions
	W	Lm	V	Hrs.	K	°		Yes/No		(a x b x c mm)
FWCL2020DL	20	1800	90-265	50,000	5000 • Daylight	120	70	no	IP65	265 x 300 x 182.7

FIREFLY 3P Weatherproof Luminaire

Use Firefly LED T8 Tubes

(See pages 2 - 5)



Item Code	Type	Wattage	IP Rating	Dimensions
FLSFWP1X20A/0	T8	1 x 20W	IP65	655 x 91 x 94
FLSFWP2X20A/0	T8	2 x 20W	IP65	655 x 138 x 94
FLSFWP1X40A/0	T8	1 x 40W	IP65	1268 x 91 x 94
FLSFWP2X40A/0	T8	2 x 40W	IP65	1268 x 138 x 94



Stainless Steel Clip
 for T8 Waterproof Luminaire
 FLSFWP-SSC/T8
 • 6 Pcs. for 20W
 • 10 Pcs. for 40W

ROYU[®]

ELECTRICAL



TIBAY NA TATAGAL



CERTIFIED
Product Safety
License No. Q-1422

BPS APPROVED
Approved by the
Bureau of Product
Standards

Please contact:



FIREFLY ELECTRIC & LIGHTING CORPORATION

7/F Zen Offices Bldg. 1111 Natividad Lopez St., Ermita, Manila, Philippines

T: (02) 7891000 (Trunkline)

www.fireflyelectric.com • info@fireflyelectric.com

Scan to see Firefly's advantage

